

5-PHASE STEPPING SYSTEMS

SANMOTION

F5

5-Phase Stepping Systems

Ver. 7
English



CONTENTS

Features	4
Setup Software	5
Customization Services	8
Lineup	6
Lineup Details	7

AC Input Drivers/Motors

System Configuration	11
Combination Table	12
Options	14
100 V Class Specifications	15
200 V Class Specifications	26
Stepping Motor Dimensions	37
Stepping Motor General Specifications	42
Driver Dimensions	43
Driver Specifications	43
Driver Part Names and Functions	44
Connections and Signals	46

DC Input Drivers/Motors

High-Power Models

System Configuration	50
Combination Table	51
Options	51
Specifications	52
Stepping Motor Dimensions	53
Stepping Motor General Specifications	54
Driver Dimensions	55
Driver Specifications	55
Driver Part Names and Functions	56
Connections and Signals	57

Basic Models

System Configuration	60
Combination Table	61
Options	61
Specifications	62
Stepping Motor Dimensions	64
Stepping Motor General Specifications	65
Driver Dimensions	66
Driver Specifications	66
Driver Part Names and Functions	67
Connections and Signals	68

Linear Actuator Stepping Motors 72 |

In-Vacuum Stepping Motors 74 |

Safety Precautions 75 |

Easy positioning control

by simple encoderless stepping systems



The SANMOTION F5 is a 5-phase stepping system that provides precise positioning with easy control. It typically has a full step angle of 0.72° and offers pulse-based precision control.

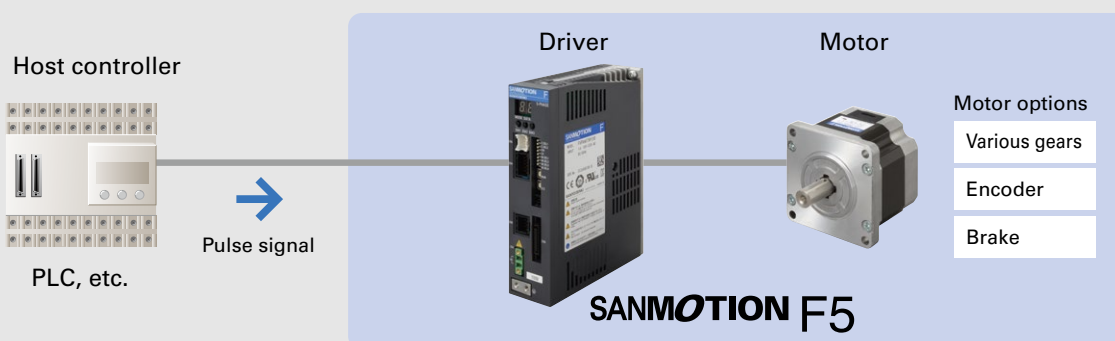

What is a stepping motor?

A stepping motor is a motor that rotates at a fixed angle for each pulse. The motor speed is controlled by the input pulse frequency. Also, the angle can be controlled by the number of command pulses. Stepping motors can be held still with holding torque, and feature stable stopping without vibrations.

Application Examples

The SANMOTION F5 can be used in a wide variety of applications, including a fixed-speed drive synchronized with command pulses, accurate positioning, and stable stopping.

- Semiconductor manufacturing equipment, analysis/inspection equipment in the medical and environmental fields, ATMs, surveillance cameras, spotlights, packaging machines, embroidering machines, automatic ticket gates, etc.

We hereby declare that the products listed in the catalog comply with the threshold values listed in Annex II, Directive (EU) 2015/863, which is an amendment to Directive 2011/65/EU of the European Parliament and of the Council of June 8, 2011 on the restriction of the use of certain hazardous substances (RoHS) in electrical and electronic equipment. However, the applications listed in ANNEX III of RoHS Directive 2011/65/EU are exempted from the restriction. Also, all models of the SANMOTION F5 drivers and motors whose model numbers begin with "SM" conform to CE/EN, UKCA, and UL as standard. AC input drivers, in addition to these, also conform to the KC Mark.



Features

Low Vibration

Speed variation during motor rotation has been reduced by about 30%⁽¹⁾ for AC input drivers and 75%⁽²⁾ for DC input drivers.

Thanks to their low-vibration mode, smooth operation is available even at low-resolution settings such as full-step and half-step modes. Vibrations can be suppressed regardless of the host controller.

Microstepping Drive

The full step angle of 0.72° can be divided into up to 250 steps in 16 levels. This realizes smooth operation with low vibration.

Moreover, the AC input drivers and the DC input high-power model drivers feature an electronic gear. Used with setup software, the motor resolution can be set according to the ball screw pitch or gear reduction ratio.

Compact Size

The high-power models of the DC input drivers are newly designed to achieve a 63% reduction in volume and a 73% reduction in mass compared to our current model.⁽²⁾

The basic models achieve a 7% reduction in volume and a 39% reduction in mass while maintaining compatibility with our current model.⁽³⁾

Analysis and Device Startup Support

Setup software allows users to adjust control parameters, analyze alarms, and monitor operating status from a PC. (For AC input drivers and high-power models of DC input drivers)

Using an encoder-mounted motor enables the monitoring of the current motor position and speed. This makes it easy to identify the causes of vibration and step-out. (For AC input drivers)

Analysis mode This mode is suitable for equipment startup and alarm analysis.

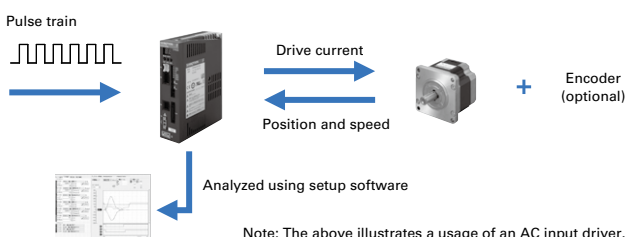

High Torque

The AC input drivers have the same output torque for both 100 and 200 VAC input voltages, there is no need to change motors even if power supply specifications are changed.

The DC input drivers have improved torque at high speeds by newly developed current control.

The high-power models, with its dedicated motor, achieved 1.5 times higher torque compared to our current drivers and the basic model achieves 1.05 times higher torque without changing motors.

Rich Lineup

Motors with 4000 P/R high-resolution encoders, electromagnetic brakes, or gears are available.

The AC input drivers automatically control the open/close motion of motors with electromagnetic brake. An external power supply for the brake is unnecessary.

Easy Replacement

The basic models of the DC input driver have mounting and interface compatibility with the current models⁽³⁾ for easy replacement.

Equipment performance can be improved by simply replacing your current stepping driver with a new model, with your current motor unchanged.

(1) Comparison with our current model: FS1W075P00

(2) Comparison with our current model: F5PAE140P100

(3) Comparison with our current model: FS1D140P10

Setup Software

This setup software allows users to set control parameters and monitor the motor operating status from PCs. It also facilitates analyzing equipment status thanks to the optimal adjustment tailored to customer equipment.

The software can be downloaded from Product Information on our website. <https://www.sanyodenki.com/>

■ Setup software name

SANMOTION MOTOR SETUP SOFTWARE

■ Supported operating systems

Windows 10/11

See our website for details on supported OS versions.

■ Main functions

Parameter settings (by group)

Diagnosis (alarm indicator, warning indicator, alarm cancellation)

Various measurement functions (operating waveform display)

A dedicated setup software connection unit is required to connect a driver to a PC.

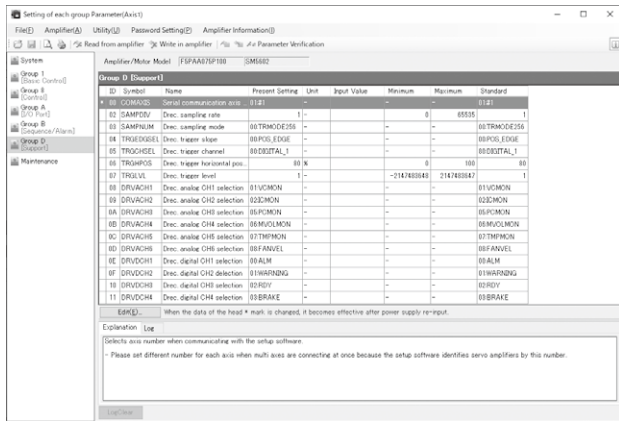

Parameter setting screen

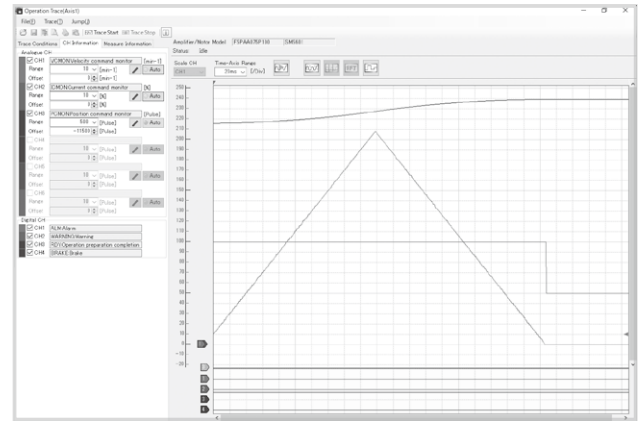

Operation tracing screen

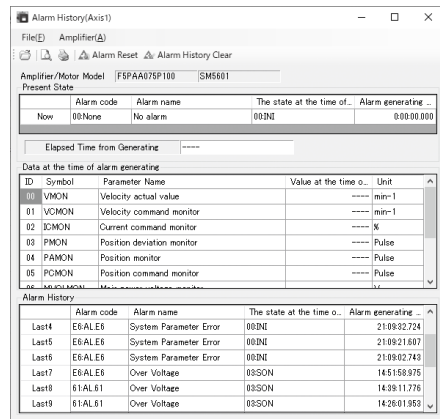

Alarm monitoring screen

Lineup

Driver

AC input



DC input High-power models



DC input Basic models

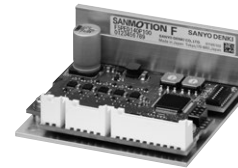

Motor

Standard models

Single-shaft and dual-shaft are available for each size. Motors whose model numbers begin with "SM" conform to CE/EN, UKCA, and UL as standard.

Low-backlash gear models

A geared motor reduces backlash using conical gears that suit gear levels.

Harmonic gear models

This model employs harmonic gears for up to 1:100 resolution.

EM brake models

This model utilizes a non-excitation electromagnetic brake to maintain position in a vertical motion and hold load even during power off.

Encoder-mounted models

Encoder models are equipped with an encoder (4000 P/R, 3-channel) and can monitor operating status such as position and speed. This simplifies determining causes of vibration and step-out.

Contact us for the combination of DC input drivers and motors with gears, brakes, or encoders.

Linear Actuator Stepping Motors

This motor employs an integrated ball screw for linear motion.



In-Vacuum Stepping Motors

We can customize motors for use in low to ultra-high vacuum environments to suit your system requirements.

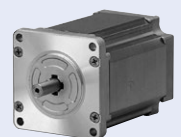

Lineup Details

Stepping Drivers/Motors ▶ p. 9–

Series		AC input	DC input High-power models	DC input Basic models
Input voltage		Single-phase 100 to 120 VAC, single-phase 200 to 240 VAC	24 VDC	24 VDC
Microsteps		5-phase mode: 1 to 250 2-phase mode: 0.4 to 102.4	5-phase mode: 1 to 250 2-phase mode: 0.4 to 102.4	5-phase mode: 1 to 250 2-phase mode: 0.4 to 102.4
Step angle		5-phase mode: 0.72 to 0.00288°/pulse 2-phase mode: 1.8 to 0.00703125°/pulse	5-phase mode: 0.72 to 0.00288°/pulse 2-phase mode: 1.8 to 0.00703125°/pulse	5-phase mode: 0.72 to 0.00288°/pulse 2-phase mode: 1.8 to 0.00703125°/pulse
Wiring of stepping motors		New pentagon configuration	New pentagon configuration	New pentagon configuration
Rated current of stepping motors		0.35 A/phase, 0.75 A/phase	2.8 A/phase	0.75 A/phase, 1.4 A/phase
Compatible motor size by model (Values in parentheses show gear ratios)	Standard models	42 mm sq./60 mm sq./86 mm sq.	60 mm sq.	28 mm sq./42 mm sq./ 60 mm sq./86 mm sq.
	Low-backlash gear models	42 mm sq./60 mm sq./86 mm sq. (1:3.6, 1:7.2, 1:10, 1:20, 1:30, 1:36)	Contact us for details	Contact us for details
	Harmonic gear models	42 mm sq./60 mm sq./86 mm sq. (1:30, 1:50, 1:100) 1:30 is only available for 42 mm sq.	Contact us for details	Contact us for details
	EM brake models	42 mm sq./60 mm sq./86 mm sq.	Contact us for details	Contact us for details
	Encoder-mounted models	42 mm sq./60 mm sq./86 mm sq.	Contact us for details	Contact us for details
Control method		Pulse input, open loop	Pulse input, open loop	Pulse input, open loop
Page		p. 11–	p. 50–	p. 60–

Note: A driver, motor, and optional motor cable and connector need to be purchased individually.

Linear Actuator Stepping Motors ▶ p. 72–

Motor size	Brake	Rated current [A/phase]	Thrust [N]	Speed [mm/s]	Model no.	Wiring
42 mm sq.	Without	0.75	370	48	SL5421-7241	New pentagon configuration
	With	0.75	370	48	SL5421-72XB41	New pentagon configuration
60 mm sq.	Without	1.4	450	64	SL5601-8241	New pentagon configuration
	With	1.4	450	64	SL5601-82XB41	New pentagon configuration

In-Vacuum Stepping Motors ▶ p. 74–

We can customize motors for use in low to ultra-high vacuum environments to suit your system requirements.

Customization Services

Custom options availability varies depending on the requested customization and quantity. Contact us for details.

Custom examples

Custom harness

Connectors, cable ties, and plastic tubing can be added.

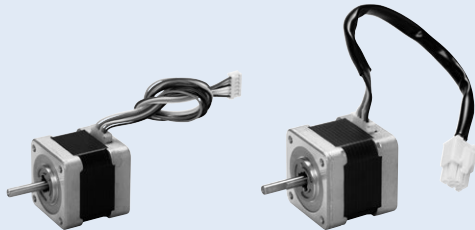

Custom shaft

We also offer custom options such as D-shaped shaft, addition of keyway and through-holes, and mounting of gear and pulley. The shaft can be made a hollow shaft for routing cables and air.

Cog wheel customization

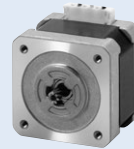

Pulley customization

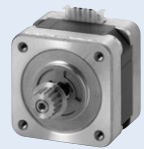

Through-hole customization

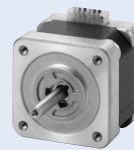

Hollow shaft

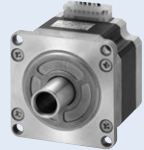

Reduction gear / encoder / brake

- A gear can be added for applications where a high load torque is exerted at low speeds.
- An encoder can be added for detecting motor position and speed.
- A brake can be added to hold the motor position at rest.

With gear and encoder



Rotary damper / mounting surface damper

A damper can be added to reduce vibrations when rotating.

Rotary damper



Surface mount damper



Stepping Drivers/Motors

AC Input

▶ p. 11

DC Input - High-Power Models

▶ p. 50

DC Input - Basic Models

▶ p. 60

How to Read Specifications

Standard models DC input driver (Model no.: F5PFD280P100) + Standard motor

RoHS

Full step angle: 0.72°

Motor size		60 mm sq.		
Motor length		49 mm	60 mm	89 mm
Single shaft	Motor model no.	SF5601-9251	SF5602-9251	SF5603-9251
Dual shaft	Motor model no.	SF5601-9221	SF5602-9221	SF5603-9221
Holding torque	N·m or more	0.5	0.83	1.55
Rotor inertia	×10 ⁻⁴ ·kg·m ²	0.2	0.31	0.6
Rated current	A/phase	2.8	2.8	2.8
Motor mass ⁽¹⁾	kg	0.62	0.8	1.27
Allowable thrust load	N	20	20	20
Allowable radial load ⁽²⁾	N	102	97	85

(1) For the driver mass, see ▶ p. 55
(2) Load is exerted to the shaft end.

Characteristics

With rubber coupling used Pull-out torque — Input current (with no load) - - - - - Input current (with load) ······ fs: Maximum starting frequency with no load ●

SF5601-9251
SF5601-9221

Winding current: 2.8 A/phase

24 VDC

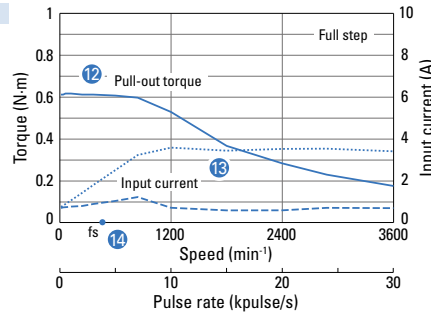

- Model number of the driver.
- The full step angle is the angle at which the motor rotates with each pulse in full step mode. In half step mode, the motor rotates by half the full step angle with each pulse.
- This is the size and length of the stepping motor.
- This is the model number of the stepping motor. The model number varies depending on whether the motor's shaft is single shaft or dual shaft.
- This is the maximum torque that is generated when the stepping motor is rotated by exerting an external force on the shaft at 4-phase excitation at the rated current.
- This is the moment of inertia of the rotor.
- This is the rated current that flows to the motor winding.
- This is the mass of the stepping motor.
- This is the maximum allowable load to the shaft in the axial direction. Take care not to exceed this limit.
- This is the maximum allowable load to the shaft in the direction perpendicular to the axial direction. Take care not to exceed this limit.
- This graph shows the relationship between the pulse rate (frequency), motor speed, and torque. The driver's input current is shown in addition to the torque.
- The pull-out torque is the maximum torque in which synchronized operation with command pulses can be maintained. If a torque that exceeds this value is applied to the stepping motor, it will be unable to synchronize with command pulses (step-out). Thus, when selecting a motor, you should allow for a torque margin of 1.4 to 2 times, in order to avoid step-out.
- This graph shows the current value of the power supply powering the driver.
 - The blue dashed lines show the source current value when there is no load (motor by itself).
 - The blue dotted lines show the source current value when the maximum torque is applied to the stepping motor (with a load).
- The blue-colored dots in the lower part of the graph show the upper limit for the maximum starting frequency (fs) of the stepping motor by itself (with no load). The stepping motor will not operate normally if it is started using pulse rates that exceed these values. For this reason, it is necessary to start the stepping motor using pulse rates that are lower than these values. The maximum starting frequency with loads (fl) can be determined using the expression below.

The required power supply capacity (W) is calculated from this graph.

$$f_L = \frac{f_s}{\sqrt{1 + \frac{J_L}{J_M}}}$$

J_M : Rotor inertia
 J_L : Load inertia
 f_s : Maximum starting frequency with no load

AC Input Drivers/Motors



Lineup RoHS

Driver CE UK CA TUV c RU us K

Model no.: F5PA□0□5P100
 Input voltage: Single-phase 100 to 120 VAC,
 single-phase 200 to 240 VAC

- The Instruction Manual is available for download from our website.

Motor CE UK CA RU c RU us K New pentagon configuration

Motor size: 42 mm sq., 60 mm sq., 86 mm sq.

Options

- Cable with connectors
- Connectors and connector sets
- Setup software connection unit

System Configuration

- ① Power supply connector CN1 (option)
- ② I/O signal cable (option)
- ③ Motor cable (option)
- ④ Encoder cable (option)
- ⑤ Setup software connection unit (option)

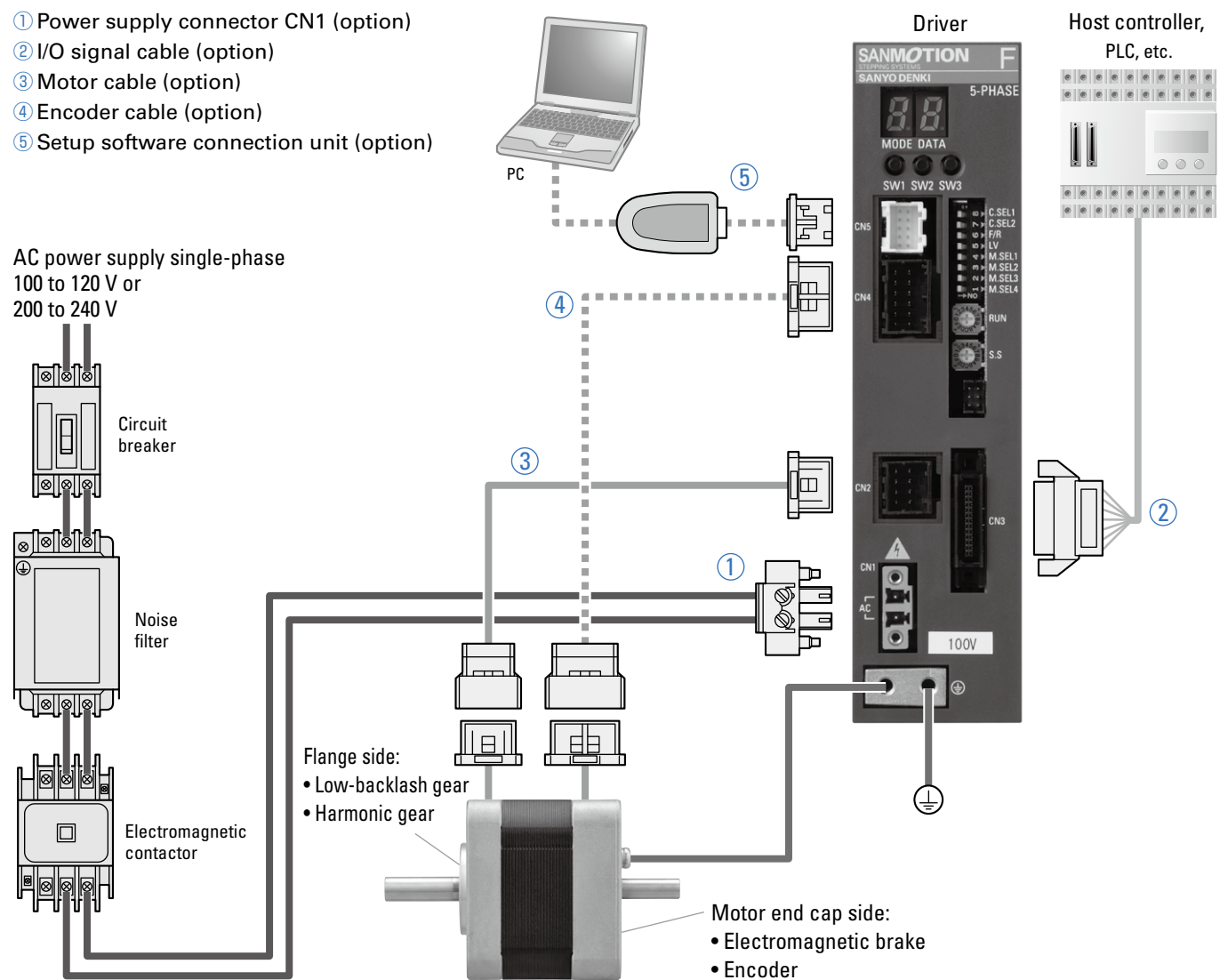

Combination Table

100 VAC

Full step angle: 0.72°

Motor						Driver (p. 43)	Options (p. 14)									
Model	Motor size	Single shaft	Dual shaft	Page		Model no.	Power cable	I/O signal cable	Motor cable	Encoder cable	Connection unit					
				Specifications	Dimensions											
Standard models	42 mm sq.	SM5421-3240	SM5421-3210	p. 15, 42	p. 37	F5PAA035P100	FC6P0000A	FC5S00□0A	FC6M00□0A	—	PBFM-U6					
		SM5422-3240	SM5422-3210	p. 15, 42	p. 37											
		SM5423-3240	SM5423-3210	p. 15, 42	p. 37											
	60 mm sq.	SM5601-7240	SM5601-7210	p. 15, 42	p. 37	F5PAA075P100	FC6P0000A	FC5S00□0A	FC6M00□0A	—	PBFM-U6					
		SM5602-7240	SM5602-7210	p. 15, 42	p. 37											
		SM5603-7240	SM5603-7210	p. 15, 42	p. 37											
	86 mm sq.	SM5861-7240	SM5861-7210	p. 16, 42	p. 37	F5PAA075P100	FC6P0000A	FC5S00□0A	FC6M00□0B	—	PBFM-U6					
SM5862-7240		SM5862-7210	p. 16, 42	p. 37												
Low-backlash gear models	42 mm sq.	SM5421-32CXA40	SM5421-32CXA10	p. 17, 42	p. 37	F5PAA035P100	FC6P0000A	FC5S00□0A	FC6M00□0A	—	PBFM-U6					
		SM5421-32CXB40	SM5421-32CXB10	p. 17, 42	p. 37											
		SM5421-32CXE40	SM5421-32CXE10	p. 17, 42	p. 37											
		SM5421-32CXG40	SM5421-32CXG10	p. 17, 42	p. 37											
		SM5421-32CXJ40	SM5421-32CXJ10	p. 17, 42	p. 37											
		SM5421-32CXK40	SM5421-32CXK10	p. 17, 42	p. 37											
	60 mm sq.	SM5601-72CXA40	SM5601-72CXA10	p. 18, 42	p. 37	F5PAA075P100	FC6P0000A	FC5S00□0A	FC6M00□0A	—	PBFM-U6					
		SM5601-72CXB40	SM5601-72CXB10	p. 18, 42	p. 37											
		SM5601-72CXE40	SM5601-72CXE10	p. 18, 42	p. 37											
		SM5601-72CXG40	SM5601-72CXG10	p. 18, 42	p. 37											
		SM5601-72CXJ40	SM5601-72CXJ10	p. 18, 42	p. 37											
		SM5601-72CXK40	SM5601-72CXK10	p. 18, 42	p. 37											
	86 mm sq.	SM5861-72CXA40	SM5861-72CXA10	p. 19, 42	p. 38	F5PAA075P100	FC6P0000A	FC5S00□0A	FC6M00□0B	—	PBFM-U6					
		SM5861-72CXB40	SM5861-72CXB10	p. 19, 42	p. 38											
		SM5861-72CXE40	SM5861-72CXE10	p. 19, 42	p. 38											
		SM5861-72CXG40	SM5861-72CXG10	p. 19, 42	p. 38											
		SM5861-72CXJ40	SM5861-72CXJ10	p. 19, 42	p. 38											
		SM5861-72CXK40	SM5861-72CXK10	p. 19, 42	p. 38											
Harmonic gear models	42 mm sq.	SM5421-32HXJ40	SM5421-32HXJ10	p. 20, 42	p. 38	F5PAA035P100	FC6P0000A	FC5S00□0A	FC6M00□0A	—	PBFM-U6					
		SM5421-32HXL40	SM5421-32HXL10	p. 20, 42	p. 38											
		SM5421-32HXM40	SM5421-32HXM10	p. 20, 42	p. 38											
	60 mm sq.	SM5601-72HXL40	SM5601-72HXL10	p. 20, 42	p. 39	F5PAA075P100	FC6P0000A	FC5S00□0A	FC6M00□0A	—	PBFM-U6					
		SM5601-72HXM40	SM5601-72HXM10	p. 20, 42	p. 39											
		SM5861-72HXL40	SM5861-72HXL10	p. 21, 42	p. 39											
86 mm sq.	SM5861-72HXM40	SM5861-72HXM10	p. 21, 42	p. 39	F5PAA075P100	FC6P0000A	FC5S00□0A	FC6M00□0B	—	PBFM-U6						
	SM5421-32XB40	—	p. 22, 42	p. 40							F5PAA035P100	FC6P0000A	FC5S00□0A	FC6M00□0A	—	PBFM-U6
	SM5422-32XB40	—	p. 22, 42	p. 40												
SM5423-32XB40	—	p. 22, 42	p. 40													
60 mm sq.	SM5601-72XB40	—	p. 22, 42	p. 40	F5PAA075P100	FC6P0000A	FC5S00□0A	FC6M00□0A	—	PBFM-U6						
	SM5602-72XB40	—	p. 22, 42	p. 40												
	SM5603-72XB40	—	p. 22, 42	p. 40												
86 mm sq.	SM5861-72XB40	—	p. 23, 42	p. 40	F5PAA075P100	FC6P0000A	FC5S00□0A	FC6M00□0B	—	PBFM-U6						
	SM5862-72XB40	—	p. 23, 42	p. 40												
	SM5863-72XB40	—	p. 23, 42	p. 40												
Encoder-mounted models	42 mm sq.	SM5421-32XE40	—	p. 24, 42	p. 40	F5PAA035P100	FC6P0000A	FC5S00□0A	FC6M00□0A	FC5E00□0A	PBFM-U6					
		SM5422-32XE40	—	p. 24, 42	p. 40											
		SM5423-32XE40	—	p. 24, 42	p. 40											
	60 mm sq.	SM5601-72XE40	—	p. 24, 42	p. 41	F5PAA075P100	FC6P0000A	FC5S00□0A	FC6M00□0A	FC5E00□0A	PBFM-U6					
		SM5602-72XE40	—	p. 24, 42	p. 41											
		SM5603-72XE40	—	p. 24, 42	p. 41											
	86 mm sq.	SM5861-72XE40	—	p. 25, 42	p. 41	F5PAA075P100	FC6P0000A	FC5S00□0A	FC6M00□0B	FC5E00□0A	PBFM-U6					
		SM5862-72XE40	—	p. 25, 42	p. 41											
		SM5863-72XE40	—	p. 25, 42	p. 41											

Note 1: Encoder specifications are 4000 P/R and 3-channel.
 Note 2: All motors listed above are the lead type with connectors.

Combination Table

200 VAC

Full step angle: 0.72°

		Motor				Driver (p. 43)	Options (p. 14)					
Model	Motor size	Single shaft	Dual shaft	Page		Model no.	Power cable	I/O signal cable	Motor cable	Encoder cable	Connection unit	
				Specifications	Dimensions							
Standard models	42 mm sq.	SM5421-3240	SM5421-3210	p. 26, 42	p. 37	F5PAB035P100	FC6P0000A	FC5S00□0A	FC6M00□0A	—	PBFM-U6	
		SM5422-3240	SM5422-3210	p. 26, 42	p. 37							
		SM5423-3240	SM5423-3210	p. 26, 42	p. 37							
	60 mm sq.	SM5601-7240	SM5601-7210	p. 26, 42	p. 37	F5PAB075P100	FC6P0000A	FC5S00□0A	FC6M00□0A	—	PBFM-U6	
		SM5602-7240	SM5602-7210	p. 26, 42	p. 37							
		SM5603-7240	SM5603-7210	p. 26, 42	p. 37							
86 mm sq.	SM5861-7240	SM5861-7210	p. 27, 42	p. 37	F5PAB075P100	FC6P0000A	FC5S00□0A	FC6M00□0B	—	PBFM-U6		
	SM5862-7240	SM5862-7210	p. 27, 42	p. 37								
Low-backlash gear models	42 mm sq.	SM5421-32CXA40	SM5421-32CXA10	p. 28, 42	p. 37	F5PAB035P100	FC6P0000A	FC5S00□0A	FC6M00□0A	—	PBFM-U6	
		SM5421-32CXB40	SM5421-32CXB10	p. 28, 42	p. 37							
		SM5421-32CXE40	SM5421-32CXE10	p. 28, 42	p. 37							
		SM5421-32CXG40	SM5421-32CXG10	p. 28, 42	p. 37							
		SM5421-32CXJ40	SM5421-32CXJ10	p. 28, 42	p. 37							
		SM5421-32CXK40	SM5421-32CXK10	p. 28, 42	p. 37							
	60 mm sq.	SM5601-72CXA40	SM5601-72CXA10	p. 29, 42	p. 37	F5PAB075P100	FC6P0000A	FC5S00□0A	FC6M00□0A	—	PBFM-U6	
		SM5601-72CXB40	SM5601-72CXB10	p. 29, 42	p. 37							
		SM5601-72CXE40	SM5601-72CXE10	p. 29, 42	p. 37							
		SM5601-72CXG40	SM5601-72CXG10	p. 29, 42	p. 37							
		SM5601-72CXJ40	SM5601-72CXJ10	p. 29, 42	p. 37							
		SM5601-72CXK40	SM5601-72CXK10	p. 29, 42	p. 37							
	86 mm sq.	SM5861-72CXA40	SM5861-72CXA10	p. 30, 42	p. 38	F5PAB075P100	FC6P0000A	FC5S00□0A	FC6M00□0B	—	PBFM-U6	
		SM5861-72CXB40	SM5861-72CXB10	p. 30, 42	p. 38							
		SM5861-72CXE40	SM5861-72CXE10	p. 30, 42	p. 38							
		SM5861-72CXG40	SM5861-72CXG10	p. 30, 42	p. 38							
		SM5861-72CXJ40	SM5861-72CXJ10	p. 30, 42	p. 38							
		SM5861-72CXK40	SM5861-72CXK10	p. 30, 42	p. 38							
	Harmonic gear models	42 mm sq.	SM5421-32HXJ40	SM5421-32HXJ10	p. 31, 42	p. 38	F5PAB035P100	FC6P0000A	FC5S00□0A	FC6M00□0A	—	PBFM-U6
			SM5421-32HXL40	SM5421-32HXL10	p. 31, 42	p. 38						
			SM5421-32HXM40	SM5421-32HXM10	p. 31, 42	p. 38						
		60 mm sq.	SM5601-72HXL40	SM5601-72HXL10	p. 31, 42	p. 39	F5PAB075P100	FC6P0000A	FC5S00□0A	FC6M00□0A	—	PBFM-U6
			SM5601-72HXM40	SM5601-72HXM10	p. 31, 42	p. 39						
			SM5861-72HXL40	SM5861-72HXL10	p. 32, 42	p. 39						
86 mm sq.	SM5861-72HXM40	SM5861-72HXM10	p. 32, 42	p. 39	F5PAB075P100	FC6P0000A	FC5S00□0A	FC6M00□0B	—	PBFM-U6		
	SM5861-72HXL40	SM5861-72HXL10	p. 32, 42	p. 39								
EM brake models	42 mm sq.	SM5421-32XB40	—	p. 33, 42	p. 40	F5PAB035P100	FC6P0000A	FC5S00□0A	FC6M00□0A	—	PBFM-U6	
		SM5422-32XB40	—	p. 33, 42	p. 40							
		SM5423-32XB40	—	p. 33, 42	p. 40							
	60 mm sq.	SM5601-72XB40	—	p. 33, 42	p. 40	F5PAB075P100	FC6P0000A	FC5S00□0A	FC6M00□0A	—	PBFM-U6	
		SM5602-72XB40	—	p. 33, 42	p. 40							
		SM5603-72XB40	—	p. 33, 42	p. 40							
86 mm sq.	SM5861-72XB40	—	p. 34, 42	p. 40	F5PAB075P100	FC6P0000A	FC5S00□0A	FC6M00□0B	—	PBFM-U6		
	SM5862-72XB40	—	p. 34, 42	p. 40								
	SM5863-72XB40	—	p. 34, 42	p. 40								
Encoder-mounted models	42 mm sq.	SM5421-32XE40	—	p. 35, 42	p. 40	F5PAB035P100	FC6P0000A	FC5S00□0A	FC6M00□0A	FC5E00□0A	PBFM-U6	
		SM5422-32XE40	—	p. 35, 42	p. 40							
		SM5423-32XE40	—	p. 35, 42	p. 40							
	60 mm sq.	SM5601-72XE40	—	p. 35, 42	p. 41	F5PAB075P100	FC6P0000A	FC5S00□0A	FC6M00□0A	FC5E00□0A	PBFM-U6	
		SM5602-72XE40	—	p. 35, 42	p. 41							
		SM5603-72XE40	—	p. 35, 42	p. 41							
86 mm sq.	SM5861-72XE40	—	p. 36, 42	p. 41	F5PAB075P100	FC6P0000A	FC5S00□0A	FC6M00□0B	FC5E00□0A	PBFM-U6		
	SM5862-72XE40	—	p. 36, 42	p. 41								
	SM5863-72XE40	—	p. 36, 42	p. 41								

Note 1: Encoder specifications are 4000 P/R and 3-channel.
 Note 2: All motors listed above are the lead type with connectors.

Options

● **Cables with connectors** AC input motors are the lead type with connectors. Connectors and connection units do not need to be prepared for motors.

I/O signal cable (CN3)

Model no.	Cable length (L)
FC5S0010A	1 m
FC5S0020A	2 m

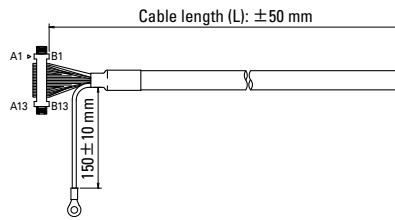

Motor/Brake cable

Model no.	Cable length (L)
FC6M0010A (for 42, 60 mm sq. models)	1 m
FC6M0010B (for 86 mm sq. models)	1 m
FC6M0020A (for 42, 60 mm sq. models)	2 m
FC6M0020B (for 86 mm sq. models)	2 m
FC6M0030A (for 42, 60 mm sq. models)	3 m
FC6M0030B (for 86 mm sq. models)	3 m

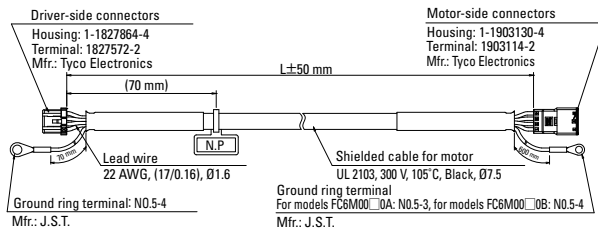

Encoder cable

Model no.	Cable length
FC5E0010A	1 m
FC5E0020A	2 m
FC5E0030A	3 m

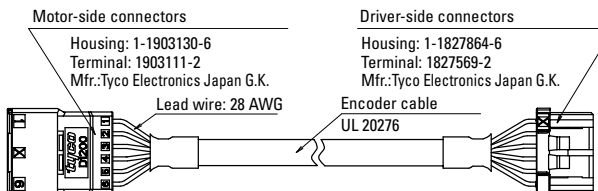

● Connectors and connector sets

Power supply connector (CN1)

Model no.	Mfr. part no.	Manufacturer
FC6P0000A	MC 1,5/ 2-STF-5,08	Phoenix Contact K.K.

I/O signal connectors Model no.: FC5S0000A

Manufacturer	Name	Mfr. part no.	Quantity
KEL CORPORATION	Connector	8822E-026-171D-F	1

Motor connector set Model no.: FC6M0000A

Manufacturer	Name	Mfr. part no.	Quantity
Tyco Electronics Japan G.K.	Recessed housing	1-1827864-4	1
	Recessed contact	1827572-2	7
	Tab housing	1-1903130-4	1
	Tab contact	1903114-2	7

Encoder connector set Model no.: FC5E0000A

Manufacturer	Name	Mfr. part no.	Quantity
Tyco Electronics Japan G.K.	Recessed housing	1-1827864-6	1
	Recessed contact	1827570-2	10
	Tab housing	1-1903130-6	1
	Tab contact	1903112-2	10

Note 1: Contact us if you need a different cable length than those listed here.

Note 2: Contact us if you need a robot cable.

Note 3: Dedicated crimping and pressure welding tools are required to assemble the harness.

Note 4: For details, refer to the specifications of each connector manufacturer.

Note 5: Refer to p. 46 to 47 for compatible wires, model number details, and connector pin assignments.

Setup software connection unit

Model: PBFM-U6

Name	Mfr. part no.	Quantity
USB/RS-485 converter	Uport 1130 (Made by MOXA)	1
Cable	PBC6T0005A (0.5 m)	1

Note: Refer to the manufacturer's website for instructions on installing the Uport 1130 driver or details on its use.

Full step angle: 0.72°

Size	Motor size	42 mm sq.			60 mm sq.		
		35 mm	41 mm	49 mm	49 mm	60 mm	89 mm
Single shaft	Motor model no.	SM5421-3240	SM5422-3240	SM5423-3240	SM5601-7240	SM5602-7240	SM5603-7240
	Driver model no.	F5PAA035P100	F5PAA035P100	F5PAA035P100	F5PAA075P100	F5PAA075P100	F5PAA075P100
Dual shaft	Motor model no.	SM5421-3210	SM5422-3210	SM5423-3210	SM5601-7210	SM5602-7210	SM5603-7210
	Driver model no.	F5PAA035P100	F5PAA035P100	F5PAA035P100	F5PAA075P100	F5PAA075P100	F5PAA075P100
Holding torque	N·m or more	0.13	0.185	0.245	0.57	0.9	1.7
Rotor inertia	×10 ⁻⁴ kg·m ²	0.028	0.045	0.056	0.2	0.31	0.6
Rated current	A/phase	0.35	0.35	0.35	0.75	0.75	0.75
Motor mass ⁽¹⁾	kg	0.24	0.31	0.38	0.62	0.8	1.27
Allowable thrust load	N	10	10	10	20	20	20
Allowable radial load ⁽²⁾	N	56	54	52	191	183	170

(1) For the driver mass, see p. 43
 (2) Load is exerted to the shaft end.

Characteristics

With rubber coupling used Pull-out torque — Input current (with no load) - - - - Input current (with load) ····· fs: Maximum starting frequency with no load ●

SM5421-3240 SM5421-3210

Winding current: 0.35A/phase

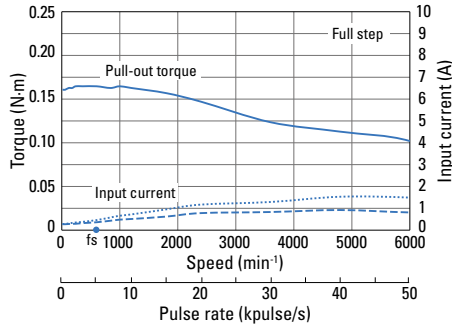

SM5422-3240 SM5422-3210

Winding current: 0.35 A/phase

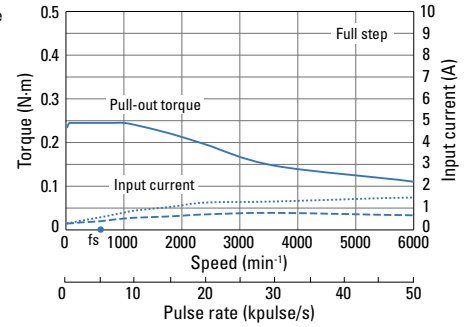

SM5423-3240 SM5423-3210

Winding current: 0.35 A/phase

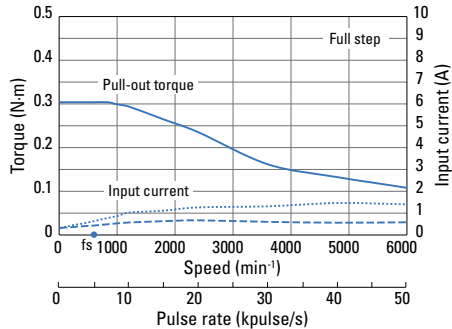

SM5601-7240 SM5601-7210

Winding current: 0.75 A/phase

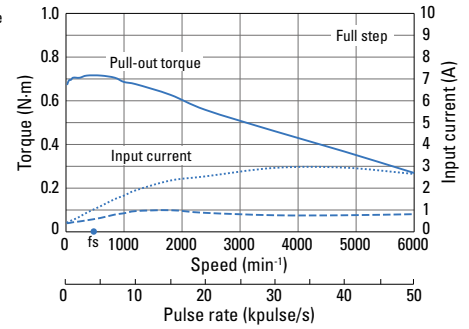

SM5602-7240 SM5602-7210

Winding current: 0.75 A/phase

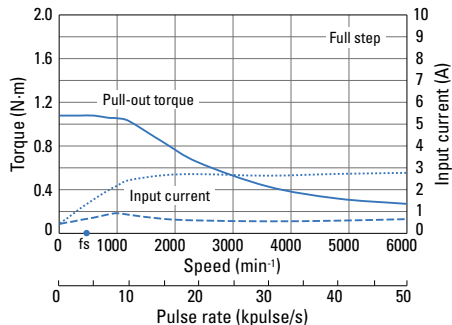

SM5603-7240 SM5603-7210

Winding current: 0.75 A/phase

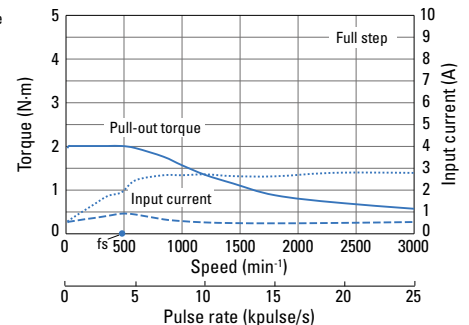

Full step angle: 0.72°

Size	Motor size	86 mm sq.		
	Motor length	66 mm	96.5 mm	127 mm
Single shaft	Motor model no.	SM5861-7240	SM5862-7240	SM5863-7240
	Driver model no.	F5PAA075P100	F5PAA075P100	F5PAA075P100
Dual shaft	Motor model no.	SM5861-7210	SM5862-7210	SM5863-7210
	Driver model no.	F5PAA075P100	F5PAA075P100	F5PAA075P100
Holding torque	N·m or more	2.3	4.4	6.8
Rotor inertia	×10 ⁻⁴ kg·m ²	1.48	3	4.5
Rated current	A/phase	0.75	0.75	0.75
Motor mass ⁽¹⁾	kg	1.75	2.9	4
Allowable thrust load	N	60	60	60
Allowable radial load ⁽²⁾	N	200	200	200

(1) For the driver mass, see ▶ p. 43
 (2) Load is exerted to the shaft end.

Characteristics

Winding current: 0.75 A/phase Pull-out torque — Input current (with no load) - - - Input current (with load) ····· fs: Maximum starting frequency with no load ●
 With rubber coupling used

SM5861-7240 SM5861-7210

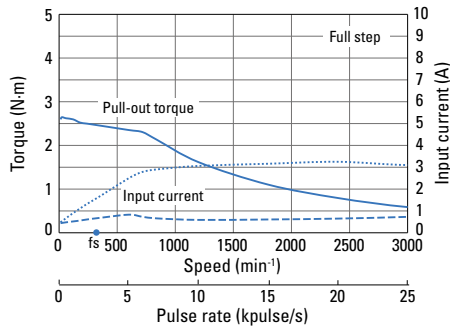

SM5862-7240 SM5862-7210

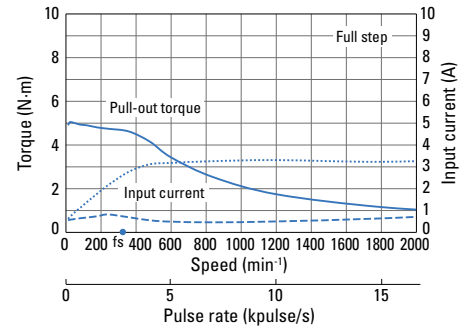

SM5863-7240 SM5863-7210

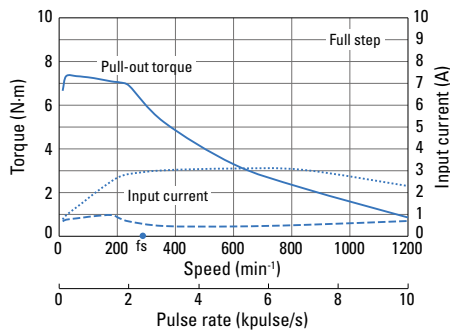

Size	Motor size		42 mm sq.					65.4 mm					
	Motor + gear length												
Single shaft	Motor model no.		SM5421-32CXA40	SM5421-32CXB40	SM5421-32CXE40	SM5421-32CXG40	SM5421-32CXJ40	SM5421-32CXA40	SM5421-32CXB40	SM5421-32CXE40	SM5421-32CXG40	SM5421-32CXJ40	SM5421-32CXA40
	Driver model no.		F5PAA035P100	F5PAA035P100	F5PAA035P100	F5PAA035P100	F5PAA035P100	F5PAA035P100	F5PAA035P100	F5PAA035P100	F5PAA035P100	F5PAA035P100	F5PAA035P100
Dual shaft	Motor model no.		SM5421-32CXA10	SM5421-32CXB10	SM5421-32CXE10	SM5421-32CXG10	SM5421-32CXJ10	SM5421-32CXA10	SM5421-32CXB10	SM5421-32CXE10	SM5421-32CXG10	SM5421-32CXJ10	SM5421-32CXA10
	Driver model no.		F5PAA035P100	F5PAA035P100	F5PAA035P100	F5PAA035P100	F5PAA035P100	F5PAA035P100	F5PAA035P100	F5PAA035P100	F5PAA035P100	F5PAA035P100	F5PAA035P100
Allowable torque	N·m		0.343	0.686	1	1.5	1.5	0.343	0.686	1	1.5	1.5	0.343
Rotor inertia	$\times 10^{-4} \text{kg}\cdot\text{m}^2$		0.028	0.028	0.028	0.028	0.028	0.028	0.028	0.028	0.028	0.028	0.028
Rated current	A/phase		0.35	0.35	0.35	0.35	0.35	0.35	0.35	0.35	0.35	0.35	0.35
Full step angle	$^\circ$		0.2	0.1	0.072	0.036	0.024	0.2	0.1	0.072	0.036	0.024	0.2
Gear ratio	—		1:3.6	1:7.2	1:10	1:20	1:30	1:3.6	1:7.2	1:10	1:20	1:30	1:3.6
Backlash	$^\circ$ or less		0.6	0.4	0.35	0.25	0.25	0.6	0.4	0.35	0.25	0.25	0.6
Allowable speed	min^{-1}		500	250	180	90	60	500	250	180	90	60	500
Motor mass ⁽¹⁾	kg		0.37	0.37	0.37	0.37	0.37	0.37	0.37	0.37	0.37	0.37	0.37
Allowable thrust load	N		15	15	15	15	15	15	15	15	15	15	15
Allowable radial load ⁽²⁾	N		20	20	20	20	20	20	20	20	20	20	20

Note: The motor and shaft rotate in the same direction for 1:3.6, 1:7.2, and 1:10 gear ratios and in the opposite directions for 1:20, 1:30, 1:36 gear ratios.

(1) For the driver mass, see ▶ p. 43

(2) Load is exerted on the point 1/3 the shaft length from the shaft end.

Characteristics

Winding current: 0.35 A/phase Allowable torque ——— Input current (with no load) - - - - - Input current (with load) ······ fs: Maximum starting frequency with no load ●

SM5421-32CXA40 SM5421-32CXA10

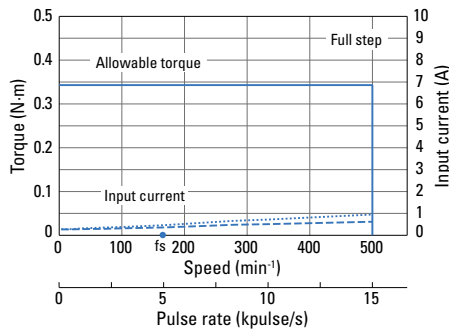

SM5421-32CXB40 SM5421-32CXB10

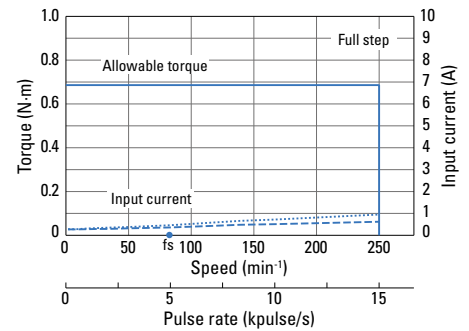

SM5421-32CXE40 SM5421-32CXE10

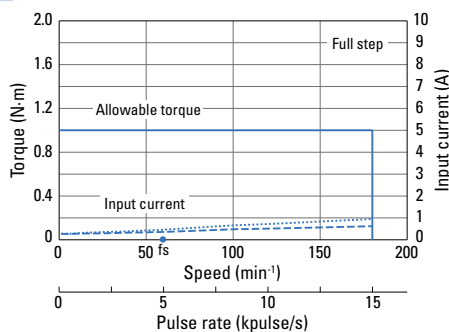

SM5421-32CXG40 SM5421-32CXG10

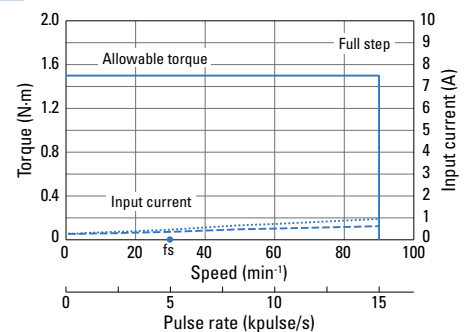

SM5421-32CXJ40 SM5421-32CXJ10

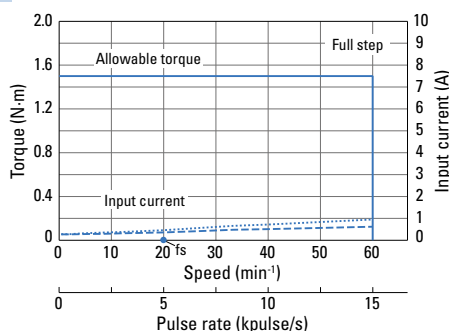

SM5421-32CXA40 SM5421-32CXA10

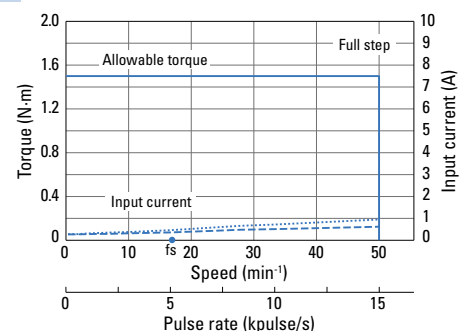

Size	Motor size		60 mm sq.							
	Motor + gear length		94.8 mm							
Single shaft	Motor model no.		SM5601-72CXA40	SM5601-72CXB40	SM5601-72CXE40	SM5601-72CXG40	SM5601-72CXJ40	SM5601-72CXK40		
	Driver model no.		F5PAA075P100	F5PAA075P100	F5PAA075P100	F5PAA075P100	F5PAA075P100	F5PAA075P100		
Dual shaft	Motor model no.		SM5601-72CXA10	SM5601-72CXB10	SM5601-72CXE10	SM5601-72CXG10	SM5601-72CXJ10	SM5601-72CXK10		
	Driver model no.		F5PAA075P100	F5PAA075P100	F5PAA075P100	F5PAA075P100	F5PAA075P100	F5PAA075P100		
Allowable torque			N·m	1.25	2.5	3	3.5	4	4	
Rotor inertia			$\times 10^{-4} \text{kg}\cdot\text{m}^2$	0.2	0.2	0.2	0.2	0.2	0.2	
Rated current			A/phase	0.75	0.75	0.75	0.75	0.75	0.75	
Full step angle			$^\circ$	0.2	0.1	0.072	0.036	0.024	0.02	
Gear ratio			—	1:3.6	1:7.2	1:10	1:20	1:30	1:36	
Backlash			$^\circ$ or less	0.55	0.25	0.25	0.17	0.17	0.17	
Allowable speed			min^{-1}	500	250	180	90	60	50	
Motor mass ⁽¹⁾			kg	1	1	1	1	1	1	
Allowable thrust load			N	30	30	30	30	30	30	
Allowable radial load ⁽²⁾			N	100	100	100	100	100	100	

Note: The motor and shaft rotate in the same direction for 1:3.6 and 1:7.2 gear ratios and in the opposite directions for 1:10, 1:20, 1:30, and 1:36 gear ratios.

(1) For the driver mass, see [p. 43](#)

(2) Load is exerted on the point 1/3 the shaft length from the shaft end.

Characteristics

Winding current: 0.75 A/phase Allowable torque — Input current (with no load) - - - - Input current (with load) ····· fs: Maximum starting frequency with no load ●

SM5601-72CXA40 SM5601-72CXA10

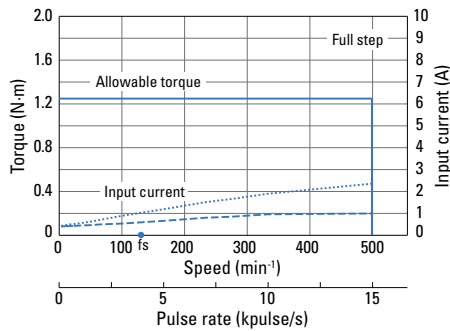

SM5601-72CXB40 SM5601-72CXB10

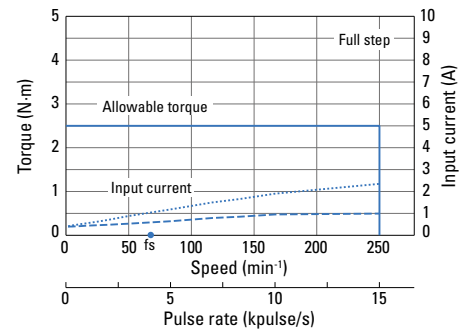

SM5601-72CXE40 SM5601-72CXE10

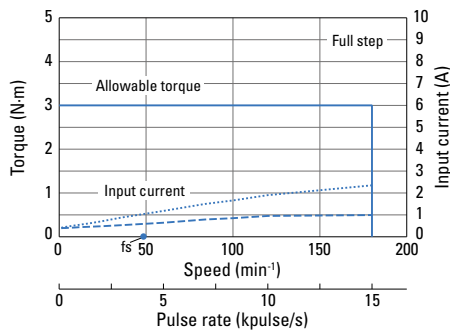

SM5601-72CXG40 SM5601-72CXG10

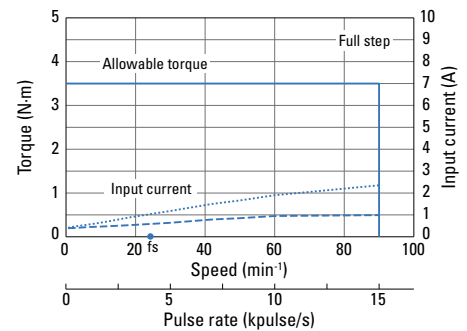

SM5601-72CXJ40 SM5601-72CXJ10

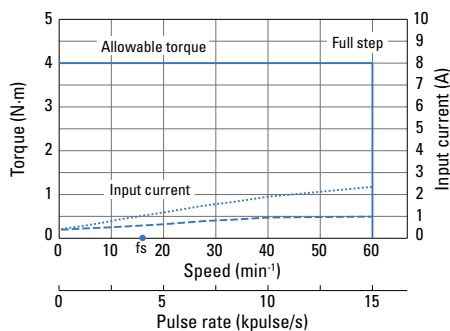

SM5601-72CXK40 SM5601-72CXK10

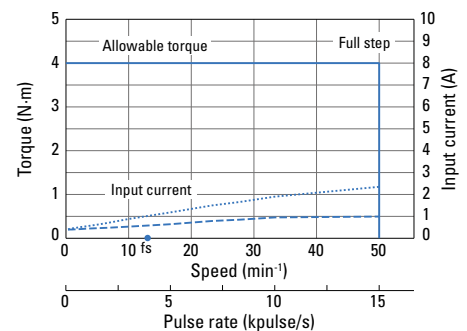

System Configuration... [p. 11](#) Combination Table... [p. 12 to 13](#) Motor Dimensions... [p. 37 to 41](#) Driver Dimensions... [p. 43](#)

If allowable torque is exceeded when using a motor with low-backlash gear, the gear may be damaged. When selecting a motor, ensure that its allowable torque will not be exceeded. Data is measured under our drive conditions. Drive torque may vary depending on the actual machine precision.

Size	Motor size		86 mm sq. (Mounting size: 90 mm sq.)							
	Motor + gear length		131 mm							
Single shaft	Motor model no.		SM5861-72CXA40	SM5861-72CXB40	SM5861-72CXE40	SM5861-72CXG40	SM5861-72CXJ40	SM5861-72CXK40		
	Driver model no.		F5PAA075P100	F5PAA075P100	F5PAA075P100	F5PAA075P100	F5PAA075P100	F5PAA075P100		
Dual shaft	Motor model no.		SM5861-72CXA10	SM5861-72CXB10	SM5861-72CXE10	SM5861-72CXG10	SM5861-72CXJ10	SM5861-72CXK10		
	Driver model no.		F5PAA075P100	F5PAA075P100	F5PAA075P100	F5PAA075P100	F5PAA075P100	F5PAA075P100		
Allowable torque		N·m	4.5	9	9	12	12	12		
Rotor inertia		×10 ⁴ ·kg·m ²	1.48	1.48	1.48	1.48	1.48	1.48		
Rated current		A/phase	0.75	0.75	0.75	0.75	0.75	0.75		
Full step angle		°	0.2	0.1	0.072	0.036	0.024	0.02		
Gear ratio		—	1:3.6	1:7.2	1:10	1:20	1:30	1:36		
Backlash		° or less	0.35	0.22	0.22	0.15	0.15	0.15		
Allowable speed		min ⁻¹	500	250	180	90	60	50		
Motor mass ⁽¹⁾		kg	2.95	2.95	2.95	2.95	2.95	2.95		
Allowable thrust load		N	60	60	60	60	60	60		
Allowable radial load ⁽²⁾		N	300	300	300	300	300	300		

Note: The motor and shaft rotate in the same direction for 1:3.6 and 1:7.2 gear ratios and in the opposite directions for 1:10, 1:20, 1:30, and 1:36 gear ratios.

(1) For the driver mass, see ▶ p. 43

(2) Load is exerted on the point 1/3 the shaft length from the shaft end.

Characteristics

Winding current: 0.75 A/phase Allowable torque ——— Input current (with no load) - - - - - Input current (with load) ······ fs: Maximum starting frequency with no load ●

SM5861-72CXA40 SM5861-72CXA10

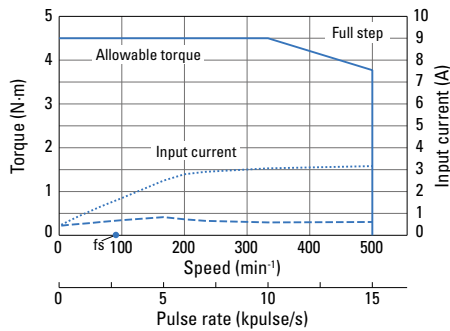

SM5861-72CXB40 SM5861-72CXB10

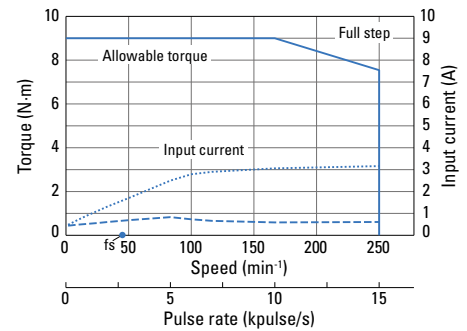

SM5861-72CXE40 SM5861-72CXE10

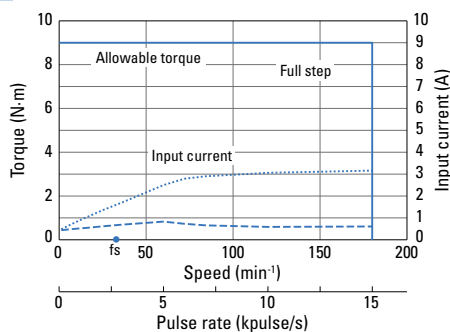

SM5861-72CXG40 SM5861-72CXG10

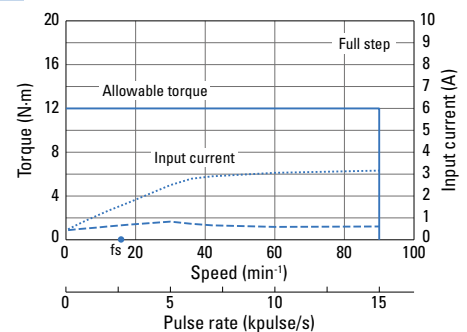

SM5861-72CXJ40 SM5861-72CXJ10

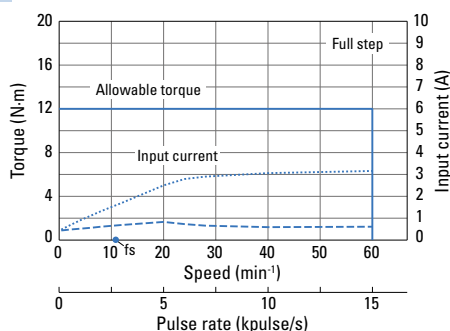

SM5861-72CXK40 SM5861-72CXK10

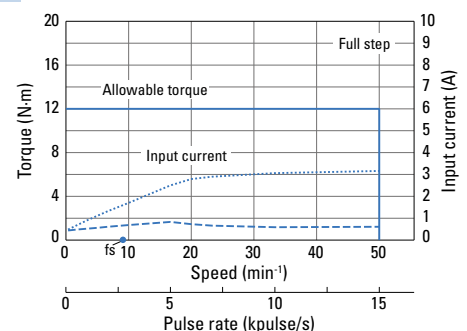

Size	Motor size	42 mm sq.			60 mm sq.	
		74.4 mm			116.3 mm	
Single shaft	Motor model no.	SM5421-32HXJ40	SM5421-32HXL40	SM5421-32HXM40	SM5601-72HXL40	SM5601-72HXM40
	Driver model no.	F5PAA035P100	F5PAA035P100	F5PAA035P100	F5PAA075P100	F5PAA075P100
Dual shaft	Motor model no.	SM5421-32HXJ10	SM5421-32HXL10	SM5421-32HXM10	SM5601-72HXL10	SM5601-72HXM10
	Driver model no.	F5PAA035P100	F5PAA035P100	F5PAA035P100	F5PAA075P100	F5PAA075P100
Allowable torque	N·m	2.2	3.5	5	5.5	8
Peak torque	N·m	4.5	8.3	11	14	20
Rotor inertia	×10 ⁻⁴ kg·m ²	0.04	0.04	0.04	0.23	0.23
Rated current	A/phase	0.35	0.35	0.35	0.75	0.75
Full step angle	°	0.024	0.0144	0.0072	0.0144	0.0072
Gear ratio	—	1:30	1:50	1:100	1:50	1:100
Hysteresis loss	arcmin or less	3.6	2.4	2.4	—	—
Lost motion	arcmin	—	—	—	0.4 to 3 (±0.28 N·m)	0.4 to 1.5 (±0.4 N·m)
Allowable speed	min ⁻¹	116	70	35	70	35
Motor mass ⁽¹⁾	kg	0.44	0.44	0.44	1.22	1.22
Allowable thrust load	N	1150	1150	1150	400	400
Allowable radial load ⁽²⁾	N	275	275	275	360	360

Note: The motor shaft and the gear output shaft rotate in the opposite directions.

(1) For the driver mass, see ▶ p. 43

(2) Load is exerted on the point 1/3 the shaft length from the shaft end.

Characteristics

Peak torque ——— Input current (with no load) ——— fs: Maximum starting frequency with no load ●
 Allowable torque ——— Input current (with load) ······

SM5421-32HXJ40 SM5421-32HXJ10

Winding current: 0.35 A/phase

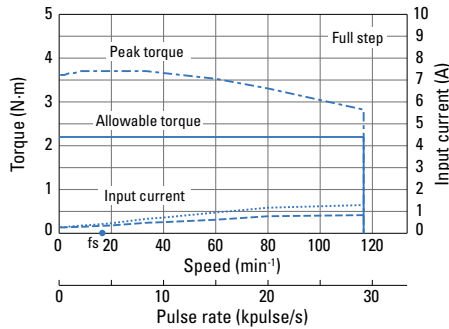

SM5421-32HXL40 SM5421-32HXL10

Winding current: 0.35 A/phase

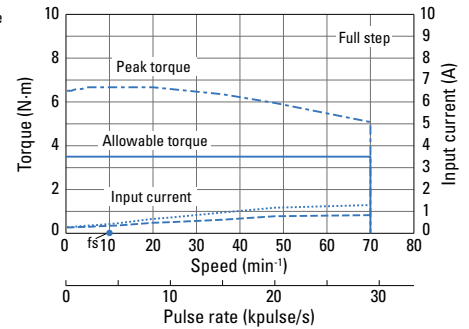

SM5421-32HXM40 SM5421-32HXM10

Winding current: 0.35 A/phase

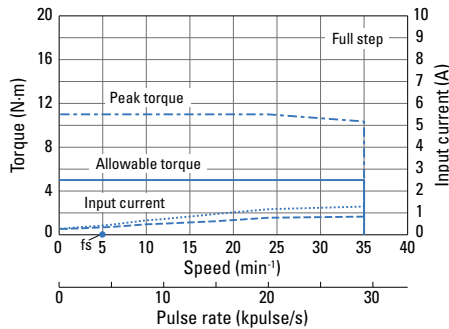

SM5601-72HXL40 SM5601-72HXL10

Winding current: 0.75 A/phase

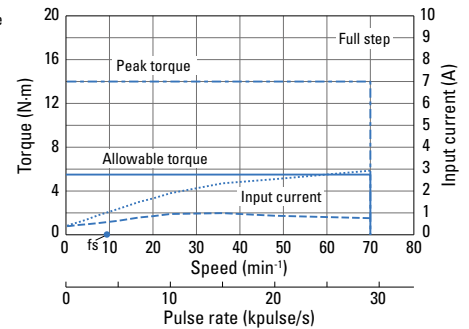

SM5601-72HXM40 SM5601-72HXM10

Winding current: 0.75 A/phase

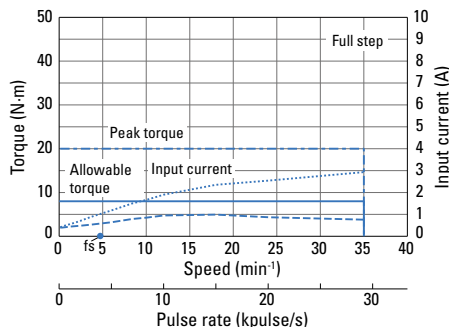

System Configuration... ▶ p. 11 Combination Table... ▶ p. 12 to 13 Motor Dimensions... ▶ p. 37 to 41 Driver Dimensions... ▶ p. 43

If peak torque is exceeded when using a motor with harmonic gear, the gear may be damaged. When selecting a motor, ensure that its allowable torque will not be exceeded. Data is measured under our drive conditions. Drive torque may vary depending on the actual machine precision.

Size	Motor size	86 mm sq. (Mounting size: 90 mm sq.)	
	Motor + gear length	148 mm	
Single shaft	Motor model no.	SM5861-72HXL40	SM5861-72HXM40
	Driver model no.	F5PAA075P100	F5PAA075P100
Dual shaft	Motor model no.	SM5861-72HXL10	SM5861-72HXM10
	Driver model no.	F5PAA075P100	F5PAA075P100
Allowable torque	N·m	25	40
Peak torque	N·m	34	59
Rotor inertia	×10 ⁻⁴ ·kg·m ²	1.68	1.68
Rated current	A/phase	0.75	0.75
Full step angle	°	0.0144	0.0072
Gear ratio	—	1:50	1:100
Hysteresis loss	arcmin or less	—	—
Lost motion	arcmin	0.4 to 3 (±1 N·m)	0.4 to 3 (±1.2 N·m)
Allowable speed	min ⁻¹	70	35
Motor mass ⁽¹⁾	kg	3.6	3.6
Allowable thrust load	N	1400	1400
Allowable radial load ⁽²⁾	N	1600	1600

Note: The motor shaft and the gear output shaft rotate in the opposite directions.

(1) For the driver mass, see ▶ p. 43

(2) Load is exerted on the point 1/3 the shaft length from the shaft end.

Characteristics

Winding current: 0.75 A/phase

Peak torque ———
Allowable torque ———

Input current (with no load) ——— fs: Maximum starting frequency with no load ●
Input current (with load) ······

SM5861-72HXL40 SM5861-72HXL10

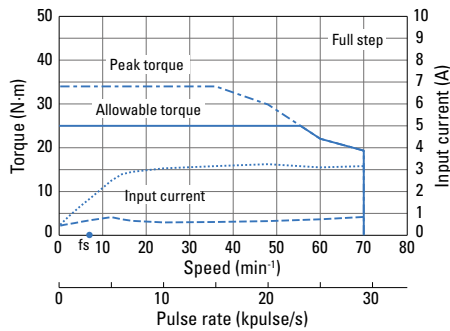

SM5861-72HXM40 SM5861-72HXM10

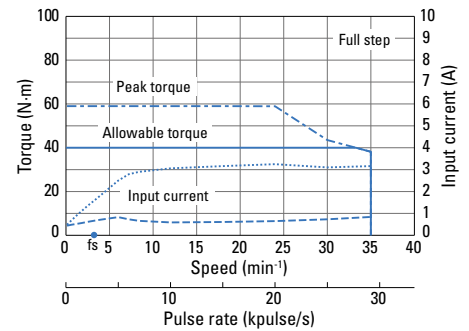

Full step angle: 0.72°

Size	Motor size	42 mm sq.			60 mm sq.			
		68 mm	74.3 mm	82 mm	91.4 mm	102.6 mm	131.3 mm	
Single shaft	Motor + brake length							
	Motor model no.	SM5421-32XB40	SM5422-32XB40	SM5423-32XB40	SM5601-72XB40	SM5602-72XB40	SM5603-72XB40	
	Driver model no.	F5PAA035P100	F5PAA035P100	F5PAA035P100	F5PAA075P100	F5PAA075P100	F5PAA075P100	
	Holding torque	N·m or more	0.13	0.185	0.245	0.57	0.9	1.7
	Rotor inertia	×10 ⁻⁴ kg·m ²	0.043	0.06	0.071	0.36	0.47	0.76
	Rated current	A/phase	0.35	0.35	0.35	0.75	0.75	0.75
	Motor mass ⁽¹⁾	kg	0.39	0.46	0.53	0.96	1.14	1.61
	Allowable thrust load	N	10	10	10	20	20	20
	Allowable radial load ⁽²⁾	N	56	54	52	191	183	170
EM brake	Brake type	—	Non-excitation type	Non-excitation type	Non-excitation type	Non-excitation type	Non-excitation type	Non-excitation type
	Input voltage	—	24 V ±5%	24 V ±5%	24 V ±5%	24 V ±5%	24 V ±5%	24 V ±5%
	Power consumption	W	2.4 (75°C)	2.4 (75°C)	2.4 (75°C)	6 (75°C)	6 (75°C)	6 (75°C)
	Static friction torque	N·m or more	0.3	0.3	0.3	0.8	0.8	0.8
	Brake engagement time	ms max.	20	20	20	20	20	20
	Brake release time	ms max.	30	30	30	30	30	30

(1) For the driver mass, see ▶ p. 43

(2) Load is exerted to the shaft end.

Characteristics

With rubber coupling used Pull-out torque — Input current (with no load) - - - - Input current (with load) ····· fs: Maximum starting frequency with no load ●

SM5421-32XB40

Winding current: 0.35 A/phase

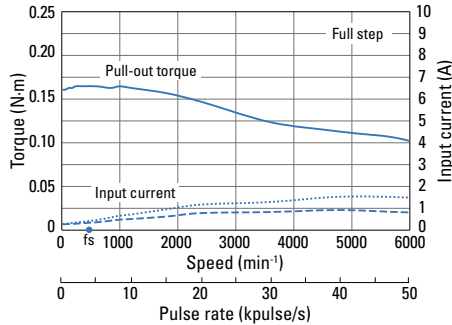

SM5422-32XB40

Winding current: 0.35 A/phase

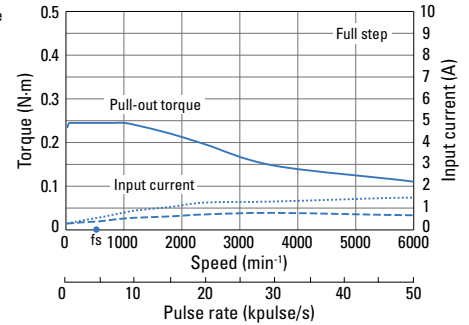

SM5423-32XB40

Winding current: 0.35 A/phase

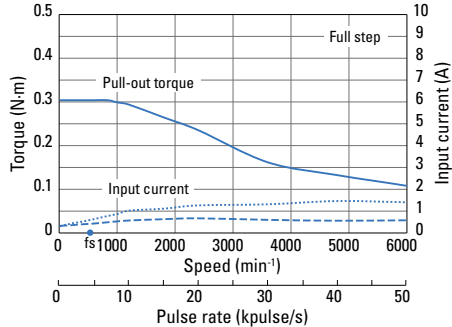

SM5601-72XB40

Winding current: 0.75 A/phase

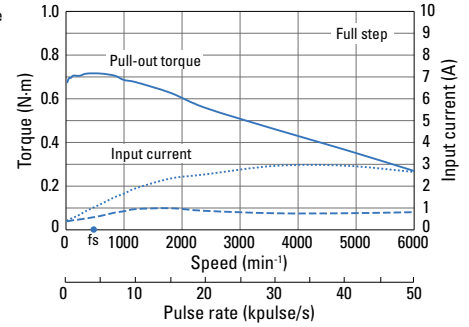

SM5602-72XB40

Winding current: 0.75 A/phase

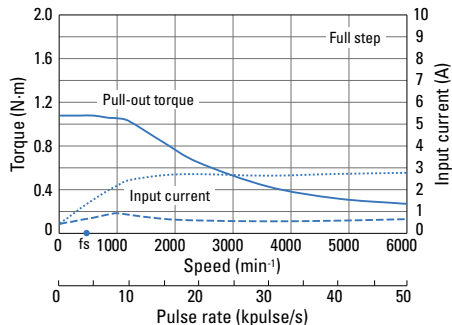

SM5603-72XB40

Winding current: 0.75 A/phase

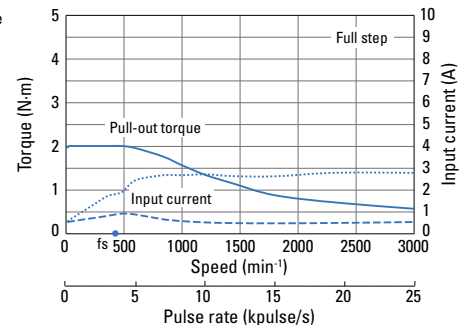

Full step angle: 0.72°

Size	Motor size	86 mm sq.		
		119.5 mm	150 mm	180.4 mm
Single shaft	Motor + brake length			
	Motor model no.	SM5861-72XB40	SM5862-72XB40	SM5863-72XB40
	Driver model no.	F5PAA075P100	F5PAA075P100	F5PAA075P100
Holding torque	N·m or more	2.3	4.4	6.8
Rotor inertia	×10 ⁻⁴ kg·m ²	2.55	4.07	5.57
Rated current	A/phase	0.75	0.75	0.75
Motor mass ⁽¹⁾	kg	2.6	3.75	4.85
Allowable thrust load	N	60	60	60
Allowable radial load ⁽²⁾	N	200	200	200
EM brake	Brake type	—	Non-excitation type	Non-excitation type
	Input voltage	—	24 V ±10%	24 V ±10%
	Power consumption	W	10.5 (20°C)	10.5 (20°C)
	Static friction torque	N·m or more	5	5
	Brake engagement time	ms max.	20	20
	Brake release time	ms max.	50	50

(1) For the driver mass, see ▶ p. 43

(2) Load is exerted to the shaft end.

Characteristics

Winding current: 0.75 A/phase Pull-out torque — Input current (with no load) - - - - Input current (with load) ····· fs: Maximum starting frequency with no load ●
 With rubber coupling used

SM5861-72XB40

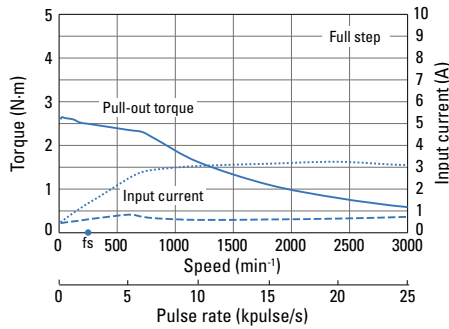

SM5862-72XB40

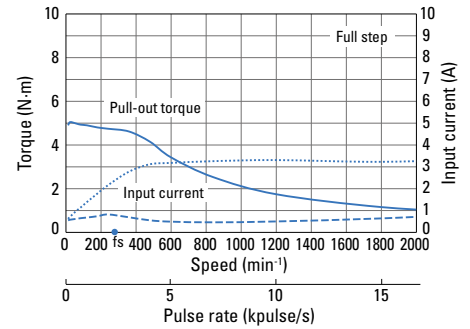

SM5863-72XB40

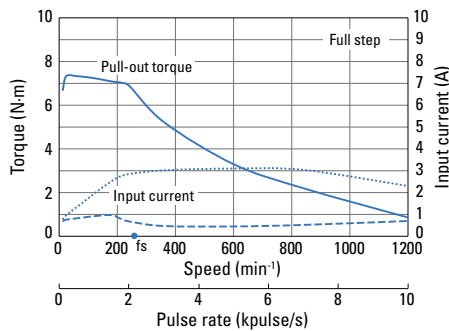

Full step angle: 0.72°

Size	Motor size		42 mm sq.			60 mm sq.		
	Motor + encoder length		51.3 mm	57.6 mm	65.3 mm	65.6 mm	76.8 mm	105.5 mm
Single shaft	Motor model no.		SM5421-32XE40	SM5422-32XE40	SM5423-32XE40	SM5601-72XE40	SM5602-72XE40	SM5603-72XE40
	Driver model no.		F5PAA035P100	F5PAA035P100	F5PAA035P100	F5PAA075P100	F5PAA075P100	F5PAA075P100
Holding torque	N·m or more		0.13	0.185	0.245	0.57	0.9	1.7
Rotor inertia	$\times 10^{-4}$ kg·m ²		0.028	0.045	0.056	0.2	0.31	0.6
Rated current	A/phase		0.35	0.35	0.35	0.75	0.75	0.75
Motor mass ⁽¹⁾	kg		0.33	0.4	0.47	0.68	0.86	1.33
Allowable thrust load	N		10	10	10	20	20	20
Allowable radial load ⁽²⁾	N		56	54	52	191	183	170
Encoder	Microsteps	P/R	4000	4000	4000	4000	4000	4000
	Number of channels	Channels	3	3	3	3	3	3
	Output circuit	—	Line driver (CMOS)	Line driver (CMOS)	Line driver (CMOS)	Line driver (CMOS)	Line driver (CMOS)	Line driver (CMOS)
	Maximum slewing frequency	kHz	220	220	220	220	220	220
	Input voltage	—	5 V \pm 5%	5 V \pm 5%	5 V \pm 5%	5 V \pm 5%	5 V \pm 5%	5 V \pm 5%
	Current consumption	mA or less	100	100	100	100	100	100

(1) For the driver mass, see ▶ p. 43

(2) Load is exerted to the shaft end.

Characteristics

With rubber coupling used Pull-out torque — Input current (with no load) - - - - - Input current (with load) ····· fs: Maximum starting frequency with no load ●

SM5421-32XE40

Winding current: 0.35 A/phase

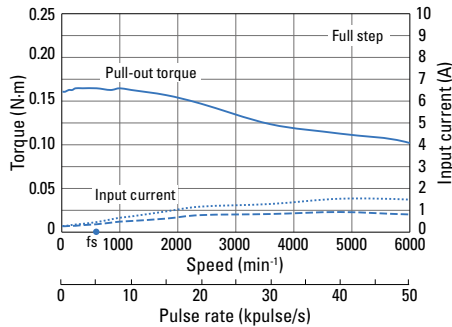

SM5422-32XE40

Winding current: 0.35 A/phase

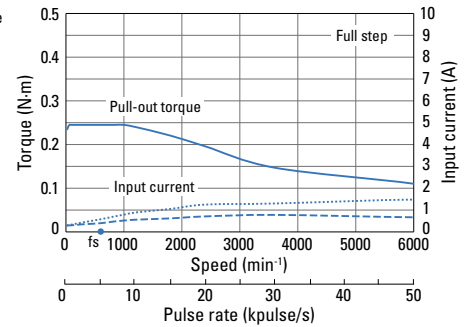

SM5423-32XE40

Winding current: 0.35 A/phase

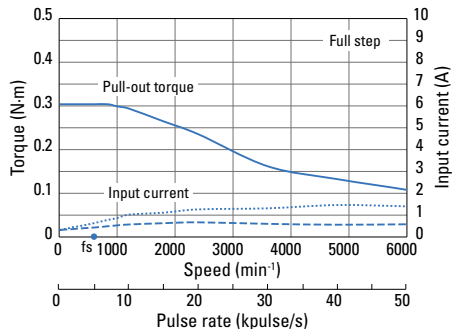

SM5601-72XE40

Winding current: 0.75 A/phase

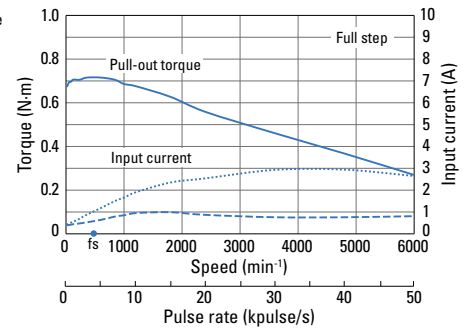

SM5602-72XE40

Winding current: 0.75 A/phase

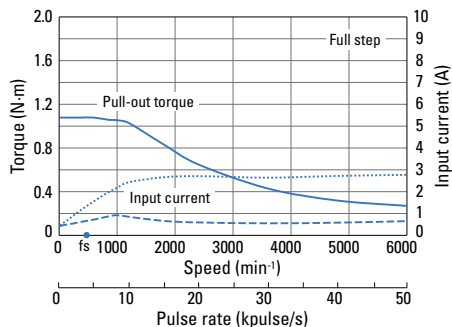

SM5603-72XE40

Winding current: 0.75 A/phase

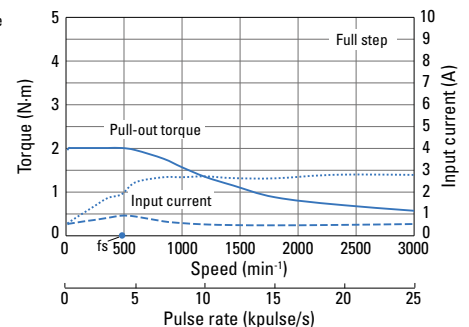

Full step angle: 0.72°

Size	Motor size		86 mm sq.		
	Motor + encoder length		79.5 mm	110 mm	140.5 mm
Single shaft	Motor model no.		SM5861-72XE40	SM5862-72XE40	SM5863-72XE40
	Driver model no.		F5PAA075P100	F5PAA075P100	F5PAA075P100
Holding torque	N·m or more		2.3	4.4	6.8
Rotor inertia	×10 ⁻⁴ kg·m ²		1.48	3	4.5
Rated current	A/phase		0.75	0.75	0.75
Motor mass ⁽¹⁾	kg		1.8	3	4.1
Allowable thrust load	N		60	60	60
Allowable radial load ⁽²⁾	N		200	200	200
Encoder	Microsteps	P/R	4000	4000	4000
	Number of channels	Channels	3	3	3
	Output circuit	—	Line driver (CMOS)	Line driver (CMOS)	Line driver (CMOS)
	Maximum slewing frequency	kHz	220	220	220
	Input voltage	—	5 V ±5%	5 V ±5%	5 V ±5%
	Current consumption	mA or less	100	100	100

(1) For the driver mass, see ▶ p. 43

(2) Load is exerted to the shaft end.

Characteristics

Winding current: 0.75 A/phase Pull-out torque — Input current (with no load) - - - - Input current (with load) ····· fs: Maximum starting frequency with no load ●
With rubber coupling used

SM5861-72XE40

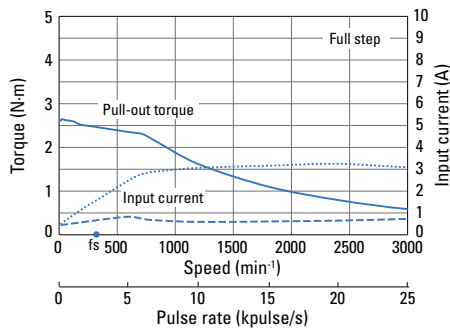

SM5862-72XE40

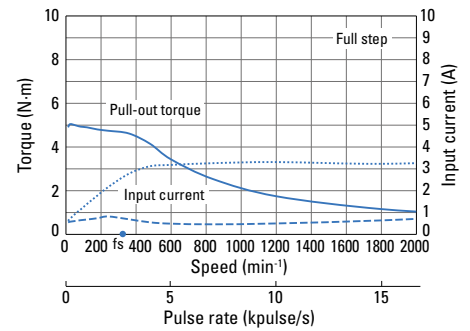

SM5863-72XE40

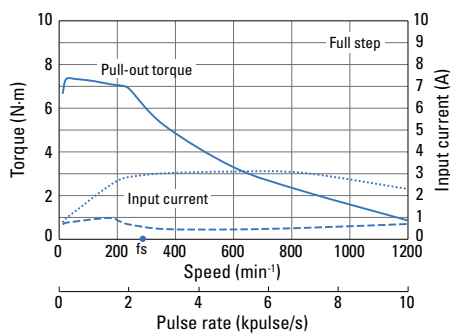

Full step angle: 0.72°

Size	Motor size	42 mm sq.			60 mm sq.		
		35 mm	41 mm	49 mm	49 mm	60 mm	89 mm
Single shaft	Motor model no.	SM5421-3240	SM5422-3240	SM5423-3240	SM5601-7240	SM5602-7240	SM5603-7240
	Driver model no.	F5PAB035P100	F5PAB035P100	F5PAB035P100	F5PAB075P100	F5PAB075P100	F5PAB075P100
Dual shaft	Motor model no.	SM5421-3210	SM5422-3210	SM5423-3210	SM5601-7210	SM5602-7210	SM5603-7210
	Driver model no.	F5PAB035P100	F5PAB035P100	F5PAB035P100	F5PAB075P100	F5PAB075P100	F5PAB075P100
Holding torque	N·m or more	0.13	0.185	0.245	0.57	0.9	1.7
Rotor inertia	×10 ⁻⁴ kg·m ²	0.028	0.045	0.056	0.2	0.31	0.6
Rated current	A/phase	0.35	0.35	0.35	0.75	0.75	0.75
Motor mass ⁽¹⁾	kg	0.24	0.31	0.38	0.62	0.8	1.27
Allowable thrust load	N	10	10	10	20	20	20
Allowable radial load ⁽²⁾	N	56	54	52	191	183	170

(1) For the driver mass, see p. 43
 (2) Load is exerted to the shaft end.

Characteristics

With rubber coupling used Pull-out torque — Input current (with no load) - - - - Input current (with load) ····· fs: Maximum starting frequency with no load ●

SM5421-3240 SM5421-3210

Winding current: 0.35 A/phase

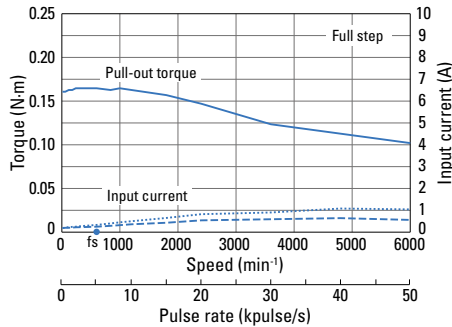

SM5422-3240 SM5422-3210

Winding current: 0.35 A/phase

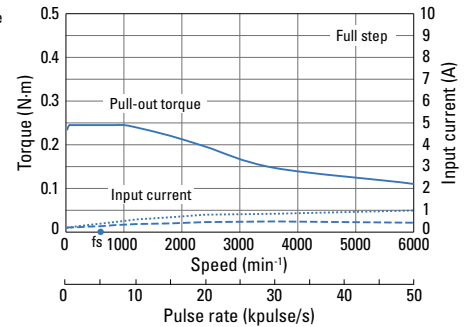

SM5423-3240 SM5423-3210

Winding current: 0.35 A/phase

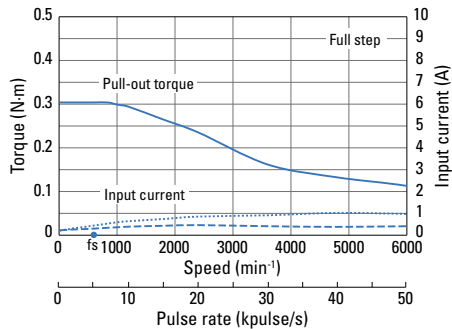

SM5601-7240 SM5601-7210

Winding current: 0.75 A/phase

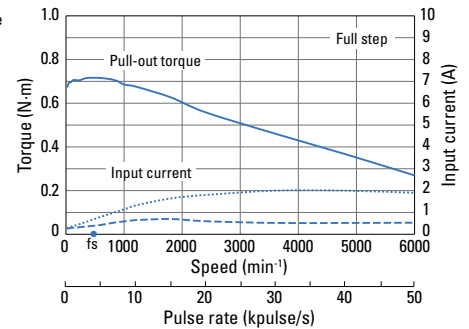

SM5602-7240 SM5602-7210

Winding current: 0.75 A/phase

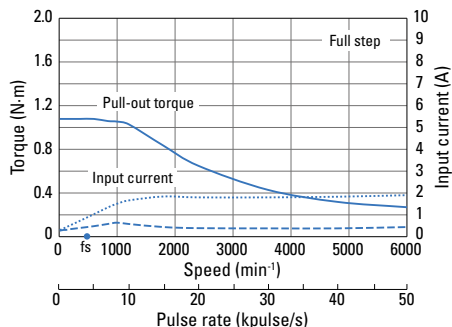

SM5603-7240 SM5603-7210

Winding current: 0.75 A/phase

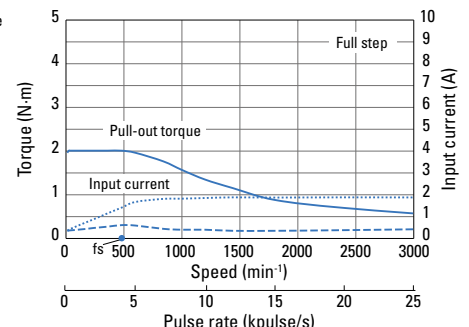

Full step angle: 0.72°

Size	Motor size	86 mm sq.		
		66 mm	96.5 mm	127 mm
Single shaft	Motor model no.	SM5861-7240	SM5862-7240	SM5863-7240
	Driver model no.	F5PAB075P100	F5PAB075P100	F5PAB075P100
Dual shaft	Motor model no.	SM5861-7210	SM5862-7210	SM5863-7210
	Driver model no.	F5PAB075P100	F5PAB075P100	F5PAB075P100
Holding torque	N-m or more	2.3	4.4	6.8
Rotor inertia	×10 ⁻⁴ kg·m ²	1.48	3	4.5
Rated current	A/phase	0.75	0.75	0.75
Motor mass ⁽¹⁾	kg	1.75	2.9	4
Allowable thrust load	N	60	60	60
Allowable radial load ⁽²⁾	N	200	200	200

(1) For the driver mass, see ▶ p. 43
 (2) Load is exerted to the shaft end.

Characteristics

Winding current: 0.75 A/phase Pull-out torque — Input current (with no load) - - - - Input current (with load) ····· fs: Maximum starting frequency with no load ●
 With rubber coupling used

SM5861-7240 SM5861-7210

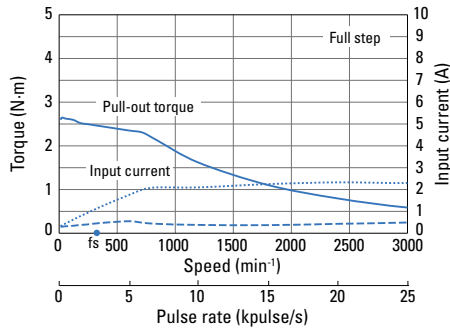

SM5862-7240 SM5862-7210

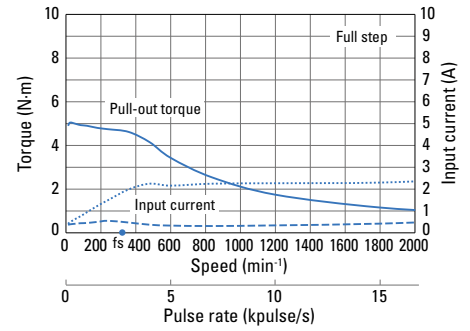

SM5863-7240 SM5863-7210

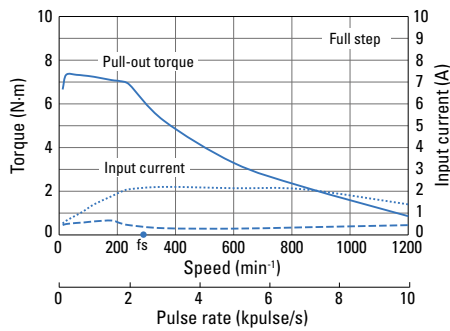

Size	Motor size		42 mm sq.							
	Motor + gear length		65.4 mm							
Single shaft	Motor model no.		SM5421-32CXA40	SM5421-32CXB40	SM5421-32CXE40	SM5421-32CXG40	SM5421-32CXJ40	SM5421-32CXX40		
	Driver model no.		F5PAB035P100	F5PAB035P100	F5PAB035P100	F5PAB035P100	F5PAB035P100	F5PAB035P100		
Dual shaft	Motor model no.		SM5421-32CXA10	SM5421-32CXB10	SM5421-32CXE10	SM5421-32CXG10	SM5421-32CXJ10	SM5421-32CXX10		
	Driver model no.		F5PAB035P100	F5PAB035P100	F5PAB035P100	F5PAB035P100	F5PAB035P100	F5PAB035P100		
Allowable torque		N·m	0.343	0.686	1	1.5	1.5	1.5		
Rotor inertia		$\times 10^{-4}$ kg·m ²	0.028	0.028	0.028	0.028	0.028	0.028		
Rated current		A/phase	0.35	0.35	0.35	0.35	0.35	0.35		
Full step angle		°	0.2	0.1	0.072	0.036	0.024	0.02		
Gear ratio		—	1:3.6	1:7.2	1:10	1:20	1:30	1:36		
Backlash		° or less	0.6	0.4	0.35	0.25	0.25	0.25		
Allowable speed		min ⁻¹	500	250	180	90	60	50		
Motor mass ⁽¹⁾		kg	0.37	0.37	0.37	0.37	0.37	0.37		
Allowable thrust load		N	15	15	15	15	15	15		
Allowable radial load ⁽²⁾		N	20	20	20	20	20	20		

Note: The motor and shaft rotate in the same direction for 1:3.6, 1:7.2, and 1:10 gear ratios and in the opposite directions for 1:20, 1:30, 1:36 gear ratios.

(1) For the driver mass, see p. 43

(2) Load is exerted on the point 1/3 the shaft length from the shaft end.

Characteristics

Winding current: 0.35 A/phase Allowable torque ——— Input current (with no load) - - - - - Input current (with load) ······ fs: Maximum starting frequency with no load ●

SM5421-32CXA40 SM5421-32CXA10

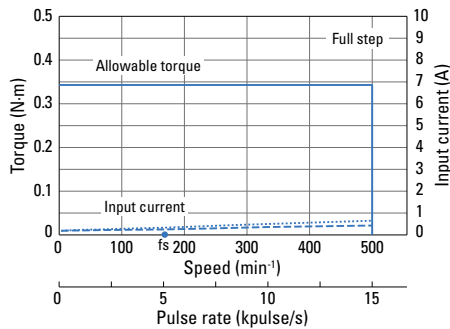

SM5421-32CXB40 SM5421-32CXB10

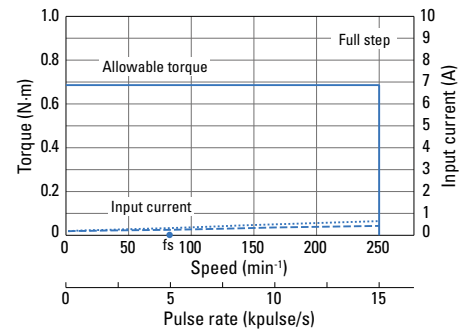

SM5421-32CXE40 SM5421-32CXE10

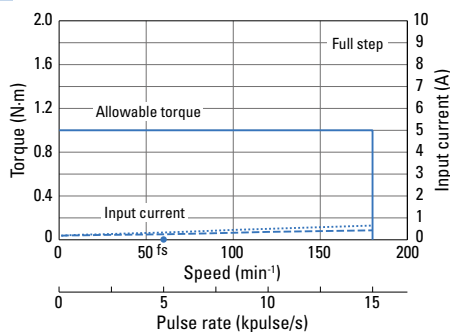

SM5421-32CXG40 SM5421-32CXG10

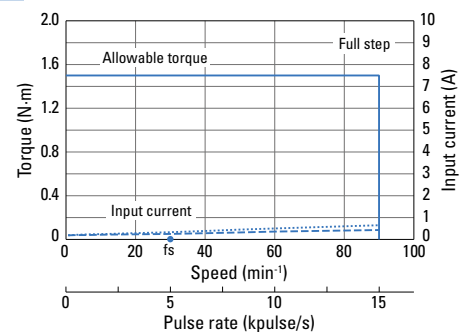

SM5421-32CXJ40 SM5421-32CXJ10

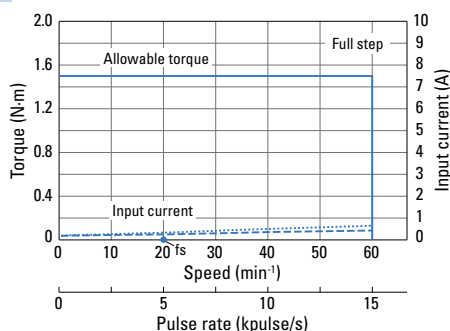

SM5421-32CXX40 SM5421-32CXX10

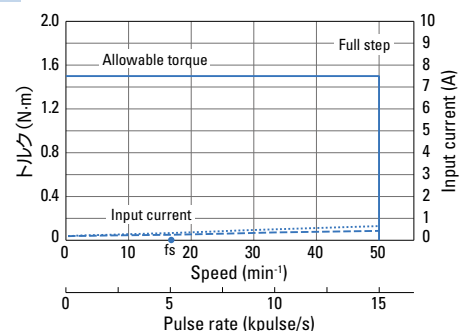

Size	Motor size	60 mm sq.					
	Motor + gear length	94.8 mm					
Single shaft	Motor model no.	SM5601-72CXA40	SM5601-72CXB40	SM5601-72CXE40	SM5601-72CXG40	SM5601-72CXJ40	SM5601-72CXK40
	Driver model no.	F5PAB075P100	F5PAB075P100	F5PAB075P100	F5PAB075P100	F5PAB075P100	F5PAB075P100
Dual shaft	Motor model no.	SM5601-72CXA10	SM5601-72CXB10	SM5601-72CXE10	SM5601-72CXG10	SM5601-72CXJ10	SM5601-72CXK10
	Driver model no.	F5PAB075P100	F5PAB075P100	F5PAB075P100	F5PAB075P100	F5PAB075P100	F5PAB075P100
Allowable torque	N·m	1.25	2.5	3	3.5	4	4
Rotor inertia	$\times 10^{-4} \text{kg}\cdot\text{m}^2$	0.2	0.2	0.2	0.2	0.2	0.2
Rated current	A/phase	0.75	0.75	0.75	0.75	0.75	0.75
Full step angle	$^\circ$	0.2	0.1	0.072	0.036	0.024	0.02
Gear ratio	—	1:3.6	1:7.2	1:10	1:20	1:30	1:36
Backlash	$^\circ$ or less	0.55	0.25	0.25	0.17	0.17	0.17
Allowable speed	min^{-1}	500	250	180	90	60	50
Motor mass ⁽¹⁾	kg	1	1	1	1	1	1
Allowable thrust load	N	30	30	30	30	30	30
Allowable radial load ⁽²⁾	N	100	100	100	100	100	100

Note: The motor and shaft rotate in the same direction for 1:3.6 and 1:7.2 gear ratios and in the opposite directions for 1:10, 1:20, 1:30, and 1:36 gear ratios.

(1) For the driver mass, see p. 43

(2) Load is exerted on the point 1/3 the shaft length from the shaft end.

Characteristics

Winding current: 0.75 A/phase Allowable torque — Input current (with no load) - - - - Input current (with load) fs: Maximum starting frequency with no load ●

SM5601-72CXA40 SM5601-72CXA10

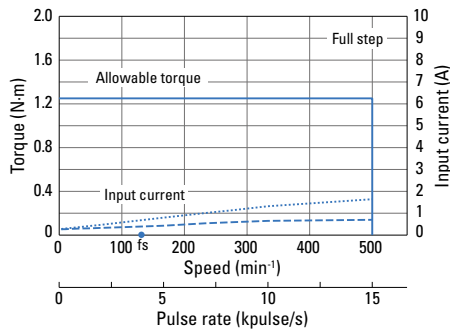

SM5601-72CXB40 SM5601-72CXB10

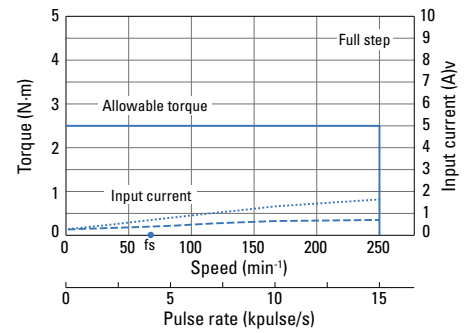

SM5601-72CXE40 SM5601-72CXE10

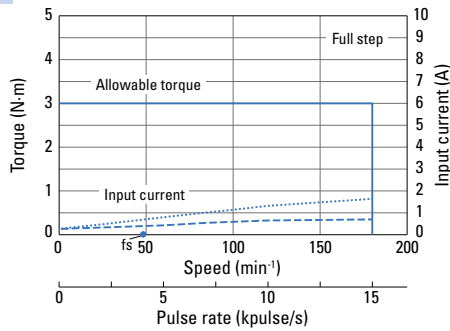

SM5601-72CXG40 SM5601-72CXG10

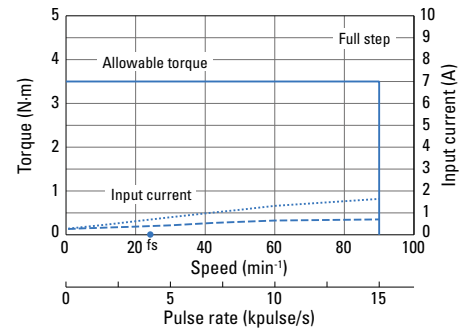

SM5601-72CXJ40 SM5601-72CXJ10

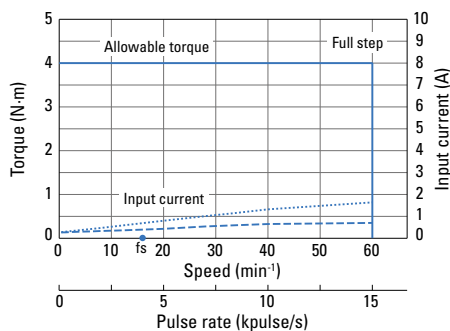

SM5601-72CXK40 SM5601-72CXK10

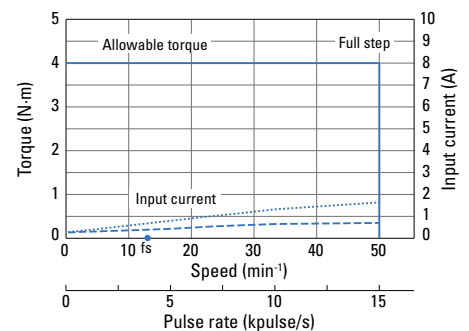

Size	Motor size	86 mm sq. (Mounting size: 90 mm sq.)					
	Motor + gear length	131 mm					
Single shaft	Motor model no.	SM5861-72CXA40	SM5861-72CXB40	SM5861-72CXE40	SM5861-72CXG40	SM5861-72CXJ40	SM5861-72CXK40
	Driver model no.	F5PAB075P100	F5PAB075P100	F5PAB075P100	F5PAB075P100	F5PAB075P100	F5PAB075P100
Dual shaft	Motor model no.	SM5861-72CXA10	SM5861-72CXB10	SM5861-72CXE10	SM5861-72CXG10	SM5861-72CXJ10	SM5861-72CXK10
	Driver model no.	F5PAB075P100	F5PAB075P100	F5PAB075P100	F5PAB075P100	F5PAB075P100	F5PAB075P100
Allowable torque	N·m	4.5	9	9	12	12	12
Rotor inertia	$\times 10^{-4}$ kg·m ²	1.48	1.48	1.48	1.48	1.48	1.48
Rated current	A/phase	0.75	0.75	0.75	0.75	0.75	0.75
Full step angle	°	0.2	0.1	0.072	0.036	0.024	0.02
Gear ratio	—	1:3.6	1:7.2	1:10	1:20	1:30	1:36
Backlash	° or less	0.35	0.22	0.22	0.15	0.15	0.13
Allowable speed	min ⁻¹	500	250	180	90	60	50
Motor mass ⁽¹⁾	kg	2.95	2.95	2.95	2.95	2.95	2.95
Allowable thrust load	N	60	60	60	60	60	60
Allowable radial load ⁽²⁾	N	300	300	300	300	300	300

Note: The motor and shaft rotate in the same direction for 1:3.6 and 1:7.2 gear ratios and in the opposite directions for 1:10, 1:20, 1:30, and 1:36 gear ratios.

(1) For the driver mass, see p. 43

(2) Load is exerted on the point 1/3 the shaft length from the shaft end.

Characteristics

Winding current: 0.75 A/phase Allowable torque ——— Input current (with no load) - - - - - Input current (with load) ······ fs: Maximum starting frequency with no load ●

SM5861-72CXA40 SM5861-72CXA10

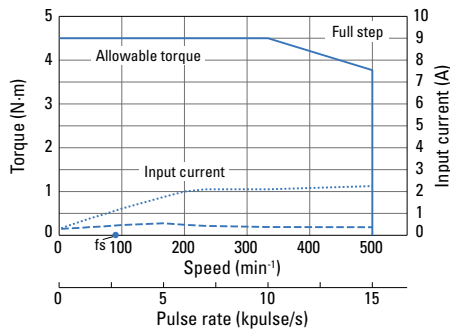

SM5861-72CXB40 SM5861-72CXB10

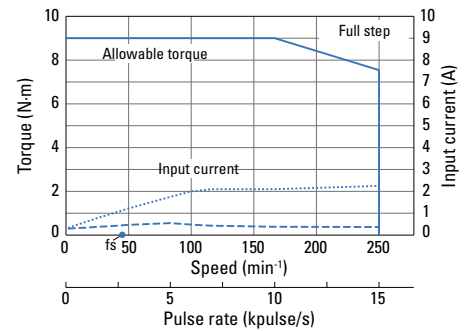

SM5861-72CXE40 SM5861-72CXE10

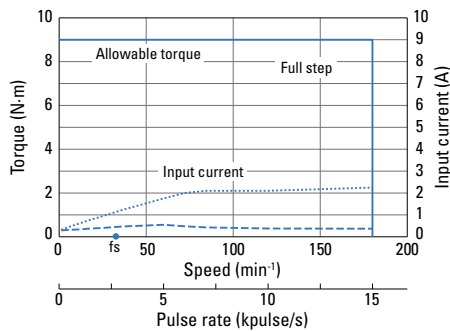

SM5861-72CXG40 SM5861-72CXG10

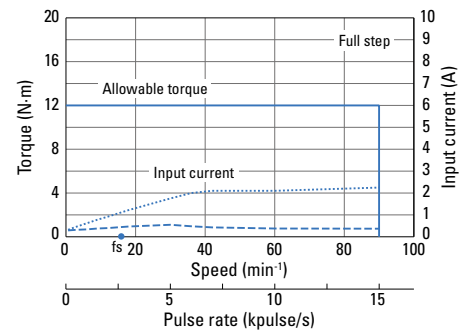

SM5861-72CXJ40 SM5861-72CXJ10

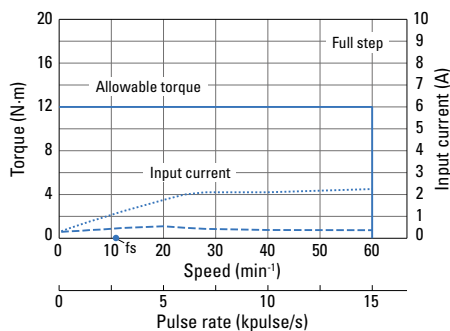

SM5861-72CXK40 SM5861-72CXK10

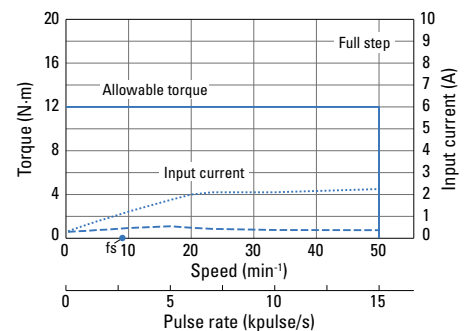

System Configuration... p. 11 Combination Table... p. 12 to 13 Motor Dimensions... p. 37 to 41 Driver Dimensions... p. 43

If allowable torque is exceeded when using a motor with low-backlash gear, the gear may be damaged. When selecting a motor, ensure that its allowable torque will not be exceeded. Data is measured under our drive conditions. Drive torque may vary depending on the actual machine precision.

Size	Motor size	42 mm sq.			60 mm sq.	
		74.4 mm			116.3 mm	
Single shaft	Motor model no.	SM5421-32HXJ40	SM5421-32HXL40	SM5421-32HXM40	SM5601-72HXL40	SM5601-72HXM40
	Driver model no.	F5PAB035P100	F5PAB035P100	F5PAB035P100	F5PAB075P100	F5PAB075P100
Dual shaft	Motor model no.	SM5421-32HXJ10	SM5421-32HXL10	SM5421-32HXM10	SM5601-72HXL10	SM5601-72HXM10
	Driver model no.	F5PAB035P100	F5PAB035P100	F5PAB035P100	F5PAB075P100	F5PAB075P100
Allowable torque	N·m	2.2	3.5	5	5.5	8
Peak torque	N·m	4.5	8.3	11	14	20
Rotor inertia	×10 ⁻⁴ kg·m ²	0.04	0.04	0.04	0.23	0.23
Rated current	A/phase	0.35	0.35	0.35	0.75	0.75
Full step angle	°	0.024	0.0144	0.0072	0.0144	0.0072
Gear ratio	—	1:30	1:50	1:100	1:50	1:100
Hysteresis loss	arcmin or less	3.6	2.4	2.4	—	—
Lost motion	arcmin	—	—	—	0.4 to 3 (±0.28 N·m)	0.4 to 1.5 (±0.4 N·m)
Allowable speed	min ⁻¹	116	70	35	70	35
Motor mass ⁽¹⁾	kg	0.44	0.44	0.44	1.22	1.22
Allowable thrust load	N	1150	1150	1150	400	400
Allowable radial load ⁽²⁾	N	275	275	275	360	360

Note: The motor shaft and the gear output shaft rotate in the opposite directions.

(1) For the driver mass, see ▶ p. 43

(2) Load is exerted on the point 1/3 the shaft length from the shaft end.

Characteristics

Peak torque ——— Input current (with no load) ——— fs: Maximum starting frequency with no load ●
 Allowable torque ——— Input current (with load) ······

SM5421-32HXJ40 SM5421-32HXJ10

Winding current: 0.35 A/phase

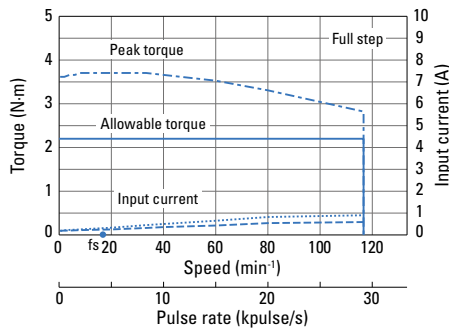

SM5421-32HXL40 SM5421-32HXL10

Winding current: 0.35 A/phase

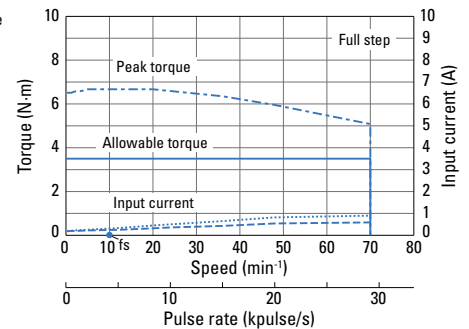

SM5421-32HXM40 SM5421-32HXM10

Winding current: 0.35 A/phase

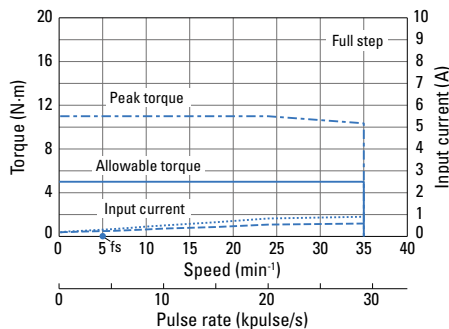

SM5601-72HXL40 SM5601-72HXL10

Winding current: 0.75 A/phase

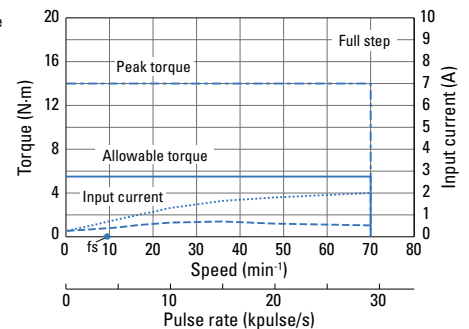

SM5601-72HXM40 SM5601-72HXM10

Winding current: 0.75 A/phase

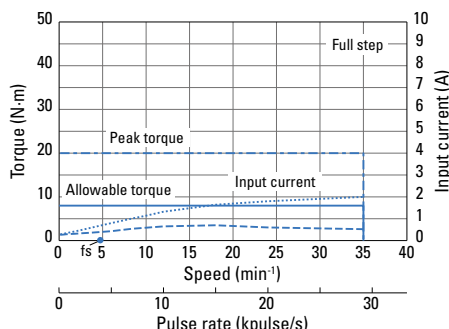

System Configuration... ▶ p. 11 Combination Table... ▶ p. 12 to 13 Motor Dimensions... ▶ p. 37 to 41 Driver Dimensions... ▶ p. 43

If peak torque is exceeded when using a motor with harmonic gear, the gear may be damaged. When selecting a motor, ensure that its allowable torque will not be exceeded. Data is measured under our drive conditions. Drive torque may vary depending on the actual machine precision.

Size	Motor size	86 mm sq. (Mounting size: 90 mm sq.)	
	Motor + gear length	148 mm	
Single shaft	Motor model no.	SM5861-72HXL40	SM5861-72HXM40
	Driver model no.	F5PAB075P100	F5PAB075P100
Dual shaft	Motor model no.	SM5861-72HXL10	SM5861-72HXM10
	Driver model no.	F5PAB075P100	F5PAB075P100
Allowable torque	N·m	25	40
Peak torque	N·m	34	59
Rotor inertia	×10 ⁻⁴ ·kg·m ²	1.68	1.68
Rated current	A/phase	0.75	0.75
Full step angle	°	0.0144	0.0072
Gear ratio	—	1:50	1:100
Hysteresis loss	arcmin or less	—	—
Lost motion	arcmin	0.4 to 3 (±1 N·m)	0.4 to 3 (±1.2 N·m)
Allowable speed	min ⁻¹	70	35
Motor mass ⁽¹⁾	kg	3.6	3.6
Allowable thrust load	N	1400	1400
Allowable radial load ⁽²⁾	N	1600	1600

Note: The motor shaft and the gear output shaft rotate in the opposite directions.

(1) For the driver mass, see ▶ p. 43

(2) Load is exerted on the point 1/3 the shaft length from the shaft end.

Characteristics

Winding current: 0.75 A/phase

Peak torque ———
Allowable torque ———

Input current (with no load) ——— fs: Maximum starting frequency with no load ●
Input current (with load) ······

SM5861-72HXL40 SM5861-72HXL10

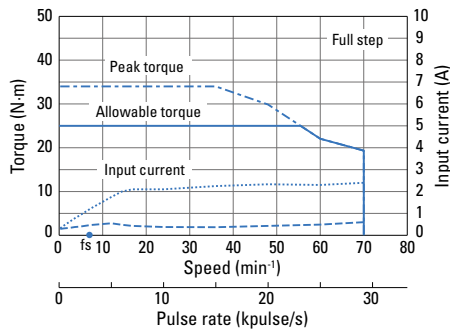

SM5861-72HXM40 SM5861-72HXM10

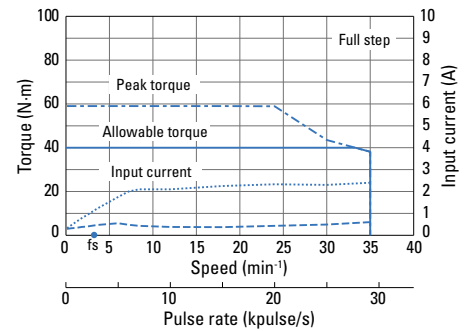

Full step angle: 0.72°

Size	Motor size	42 mm sq.			60 mm sq.			
		68 mm	74.3 mm	82 mm	91.4 mm	102.6 mm	131.3 mm	
Single shaft	Motor + brake length							
	Motor model no.	SM5421-32XB40	SM5422-32XB40	SM5423-32XB40	SM5601-72XB40	SM5602-72XB40	SM5603-72XB40	
	Driver model no.	F5PAB035P100	F5PAB035P100	F5PAB035P100	F5PAB075P100	F5PAB075P100	F5PAB075P100	
	Holding torque	N-m or more	0.13	0.185	0.245	0.57	0.9	1.7
	Rotor inertia	×10 ⁻⁴ kg·m ²	0.043	0.06	0.071	0.36	0.47	0.76
	Rated current	A/phase	0.35	0.35	0.35	0.75	0.75	0.75
	Motor mass ⁽¹⁾	kg	0.39	0.46	0.53	0.96	1.14	1.61
	Allowable thrust load	N	10	10	10	20	20	20
	Allowable radial load ⁽²⁾	N	56	54	52	191	183	170
EM brake	Brake type	—	Non-excitation type	Non-excitation type	Non-excitation type	Non-excitation type	Non-excitation type	Non-excitation type
	Input voltage	—	24 V ±5%	24 V ±5%	24 V ±5%	24 V ±5%	24 V ±5%	24 V ±5%
	Power consumption	W	2.4 (75°C)	2.4 (75°C)	2.4 (75°C)	6 (75°C)	6 (75°C)	6 (75°C)
	Static friction torque	N-m or more	0.3	0.3	0.3	0.8	0.8	0.8
	Brake engagement time	ms max.	20	20	20	20	20	20
	Brake release time	ms max.	30	30	30	30	30	30

(1) For the driver mass, see ▶ p. 43
 (2) Load is exerted to the shaft end.

Characteristics

With rubber coupling used Pull-out torque — Input current (with no load) - - - - - Input current (with load) ····· fs: Maximum starting frequency with no load ●

SM5421-32XB40

Winding current: 0.35 A/phase

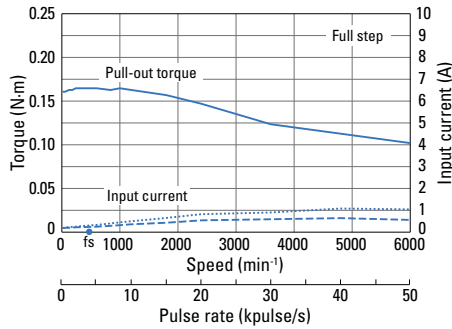

SM5422-32XB40

Winding current: 0.35 A/phase

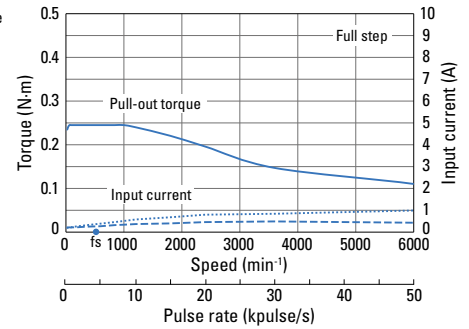

SM5423-32XB40

Winding current: 0.35 A/phase

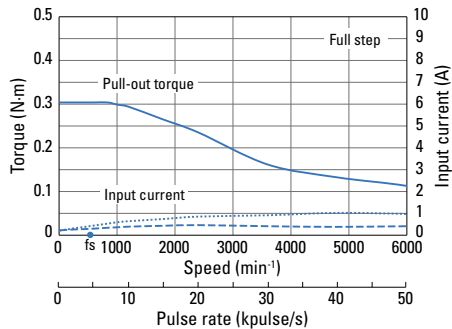

SM5601-72XB40

Winding current: 0.75 A/phase

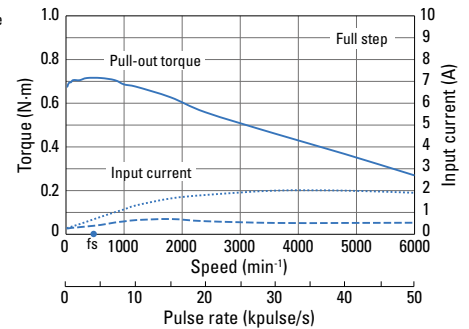

SM5602-72XB40

Winding current: 0.75 A/phase

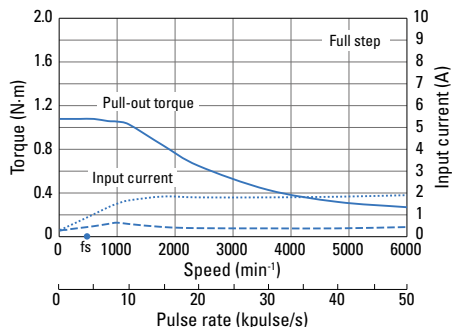

SM5603-72XB40

Winding current: 0.75 A/phase

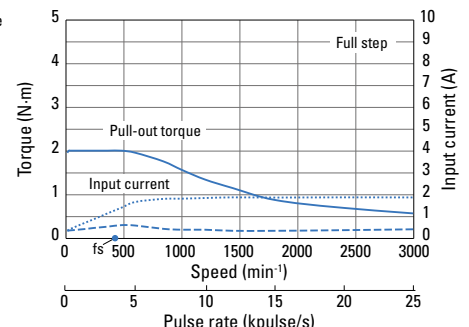

Full step angle: 0.72°

Size	Motor size	86 mm sq.		
		119.5 mm	150 mm	180.4 mm
Single shaft	Motor + brake length			
	Motor model no.	SM5861-72XB40	SM5862-72XB40	SM5863-72XB40
	Driver model no.	F5PAB075P100	F5PAB075P100	F5PAB075P100
Holding torque	N·m or more	2.3	4.4	6.8
Rotor inertia	×10 ⁻⁴ kg·m ²	2.55	4.07	5.57
Rated current	A/phase	0.75	0.75	0.75
Motor mass ⁽¹⁾	kg	2.6	3.75	4.85
Allowable thrust load	N	60	60	60
Allowable radial load ⁽²⁾	N	200	200	200
EM brake	Brake type	—	Non-excitation type	Non-excitation type
	Input voltage	—	24 V ±10%	24 V ±10%
	Power consumption	W	10.5 (20°C)	10.5 (20°C)
	Static friction torque	N·m or more	5	5
	Brake engagement time	ms max.	20	20
	Brake release time	ms max.	50	50

(1) For the driver mass, see ▶ p. 43
 (2) Load is exerted to the shaft end.

Characteristics

Winding current: 0.75 A/phase Pull-out torque — Input current (with no load) - - - - Input current (with load) ····· fs: Maximum starting frequency with no load ●
 With rubber coupling used

SM5861-72XB40

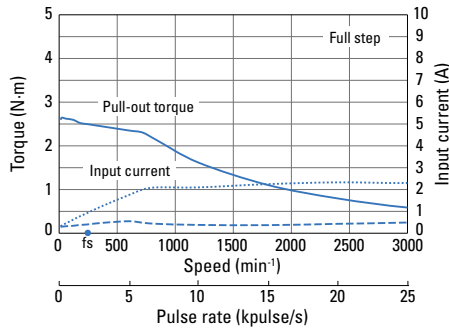

SM5862-72XB40

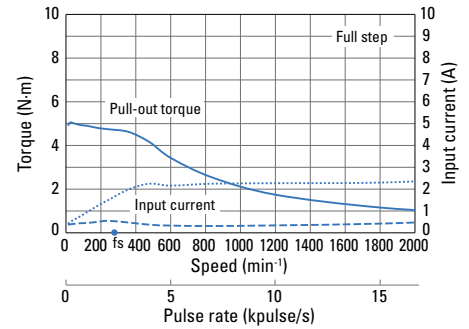

SM5863-72XB40

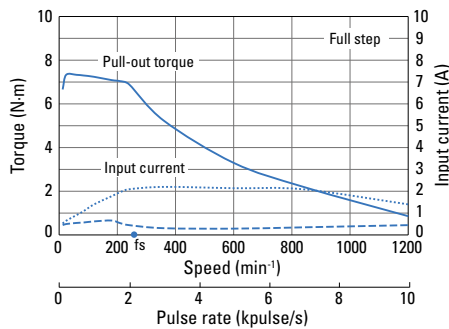

Full step angle: 0.72°

Size	Motor size		42 mm sq.			60 mm sq.		
	Motor + encoder length		51.3 mm	57.6 mm	65.3 mm	65.6 mm	76.8 mm	105.5 mm
Single shaft	Motor model no.		SM5421-32XE40	SM5422-32XE40	SM5423-32XE40	SM5601-72XE40	SM5602-72XE40	SM5603-72XE40
	Driver model no.		F5PAB035P100	F5PAB035P100	F5PAB035P100	F5PAB075P100	F5PAB075P100	F5PAB075P100
Holding torque	N·m or more		0.13	0.185	0.245	0.57	0.9	1.7
Rotor inertia	×10 ⁻⁴ kg·m ²		0.028	0.045	0.056	0.2	0.31	0.6
Rated current	A/phase		0.35	0.35	0.35	0.75	0.75	0.75
Motor mass ⁽¹⁾	kg		0.33	0.4	0.47	0.68	0.86	1.33
Allowable thrust load	N		10	10	10	20	20	20
Allowable radial load ⁽²⁾	N		56	54	52	191	183	170
Encoder	Microsteps	P/R	4000	4000	4000	4000	4000	4000
	Number of channels	Channels	3	3	3	3	3	3
	Output circuit	—	Line driver (CMOS)	Line driver (CMOS)	Line driver (CMOS)	Line driver (CMOS)	Line driver (CMOS)	Line driver (CMOS)
	Maximum slewing frequency	kHz	220	220	220	220	220	220
	Input voltage	—	5 V ±5%	5 V ±5%	5 V ±5%	5 V ±5%	5 V ±5%	5 V ±5%
	Current consumption	mA or less	100	100	100	100	100	100

(1) For the driver mass, see ▶ p. 43

(2) Load is exerted to the shaft end.

Characteristics

With rubber coupling used Pull-out torque — Input current (with no load) - - - - - Input current (with load) ······ fs: Maximum starting frequency with no load ●

SM5421-32XE40

Winding current: 0.35 A/phase

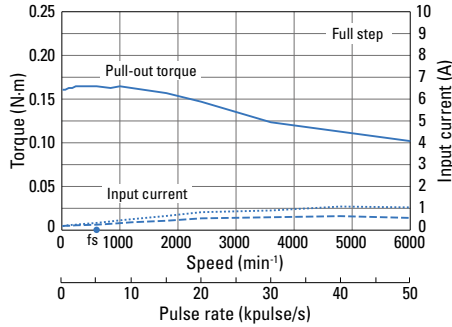

SM5422-32XE40

Winding current: 0.35 A/phase

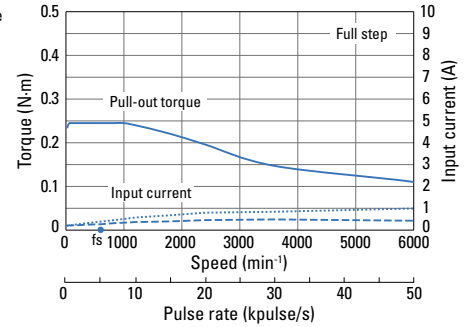

SM5423-32XE40

Winding current: 0.35 A/phase

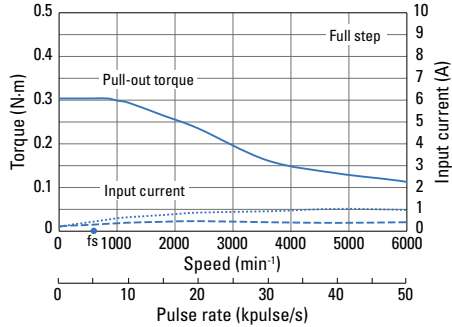

SM5601-72XE40

Winding current: 0.75 A/phase

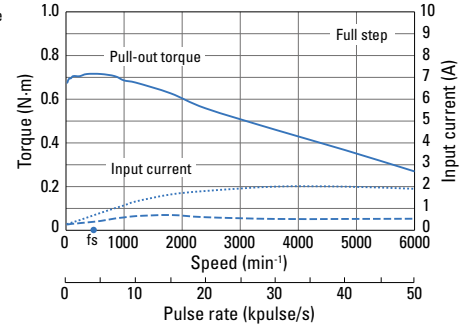

SM5602-72XE40

Winding current: 0.75 A/phase

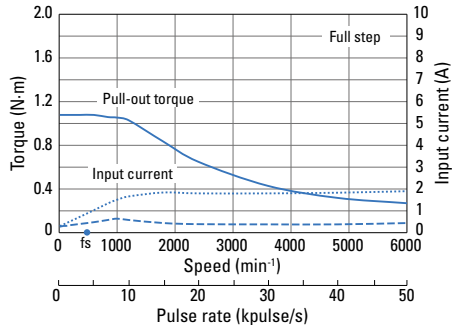

SM5603-72XE40

Winding current: 0.75 A/phase

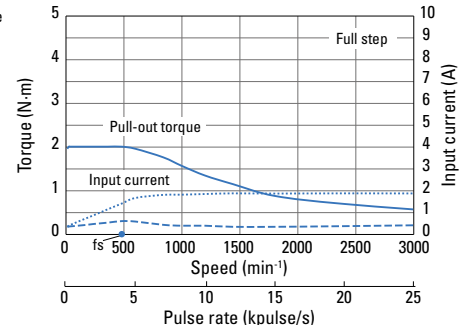

Full step angle: 0.72°

Size	Motor size	86 mm sq.			
	Motor + encoder length	79.5 mm	110 mm	140.5 mm	
Single shaft	Motor model no.	SM5861-72XE40	SM5862-72XE40	SM5863-72XE40	
	Driver model no.	F5PAB075P100	F5PAB075P100	F5PAB075P100	
Holding torque	N·m or more	2.3	4.4	6.8	
Rotor inertia	×10 ⁻⁴ kg·m ²	1.48	3	4.5	
Rated current	A/phase	0.75	0.75	0.75	
Motor mass ⁽¹⁾	kg	1.8	3	4.1	
Allowable thrust load	N	60	60	60	
Allowable radial load ⁽²⁾	N	200	200	200	
Encoder	Microsteps	P/R	4000	4000	4000
	Number of channels	Channels	3	3	3
	Output circuit	—	Line driver (CMOS)	Line driver (CMOS)	Line driver (CMOS)
	Maximum slewing frequency	kHz	220	220	220
	Input voltage	—	5 V ±5%	5 V ±5%	5 V ±5%
	Current consumption	mA or less	100	100	100

(1) For the driver mass, see ▶ p. 43

(2) Load is exerted to the shaft end.

Characteristics

Winding current: 0.75 A/phase Pull-out torque ——— Input current (with no load) - - - - - Input current (with load) ······ fs: Maximum starting frequency with no load ●
 With rubber coupling used

SM5861-72XE40

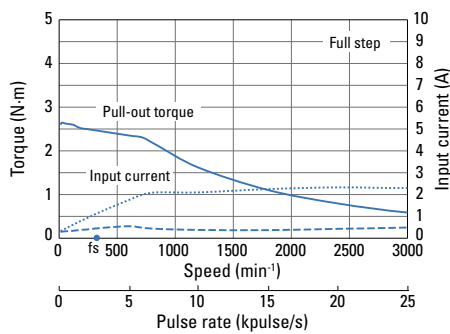

SM5862-72XE40

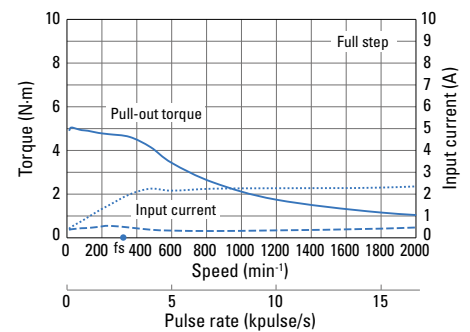

SM5863-72XE40

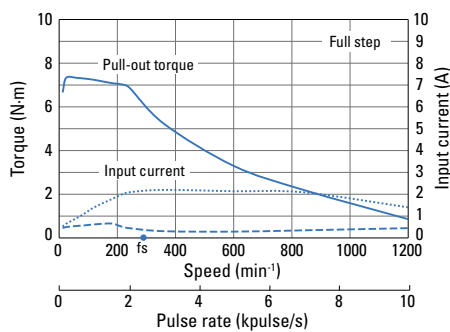

Stepping Motor Dimensions Unit: mm

Low-backlash gear models

86 mm sq.

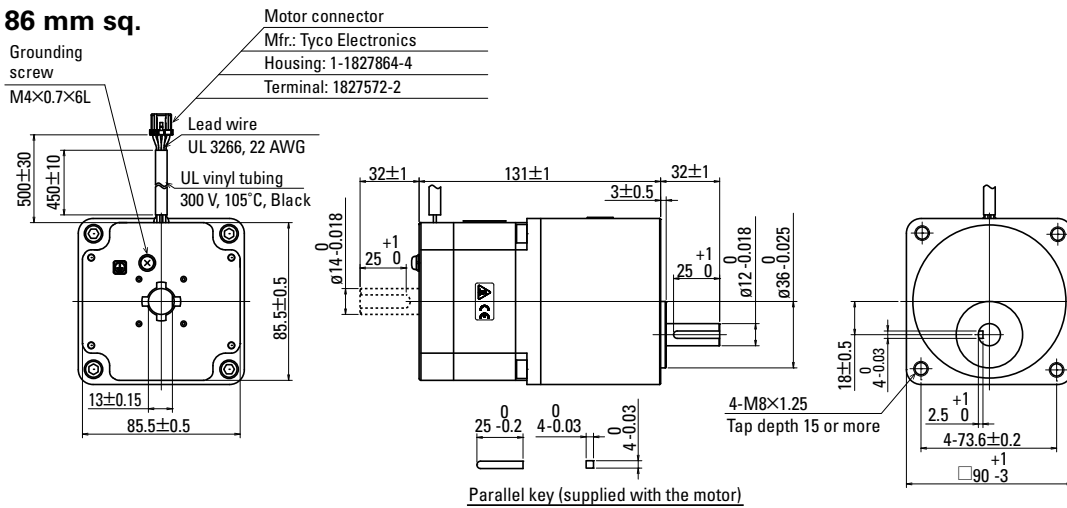

Motor model no.	
Single shaft	Dual shaft
SM5861-72CXA40	SM5861-72CXA10
SM5861-72CXB40	SM5861-72CXB10
SM5861-72CXE40	SM5861-72CXE10
SM5861-72CXG40	SM5861-72CXG10
SM5861-72CXJ40	SM5861-72CXJ10
SM5861-72CXK40	SM5861-72CXK10

Harmonic gear models

42 mm sq.

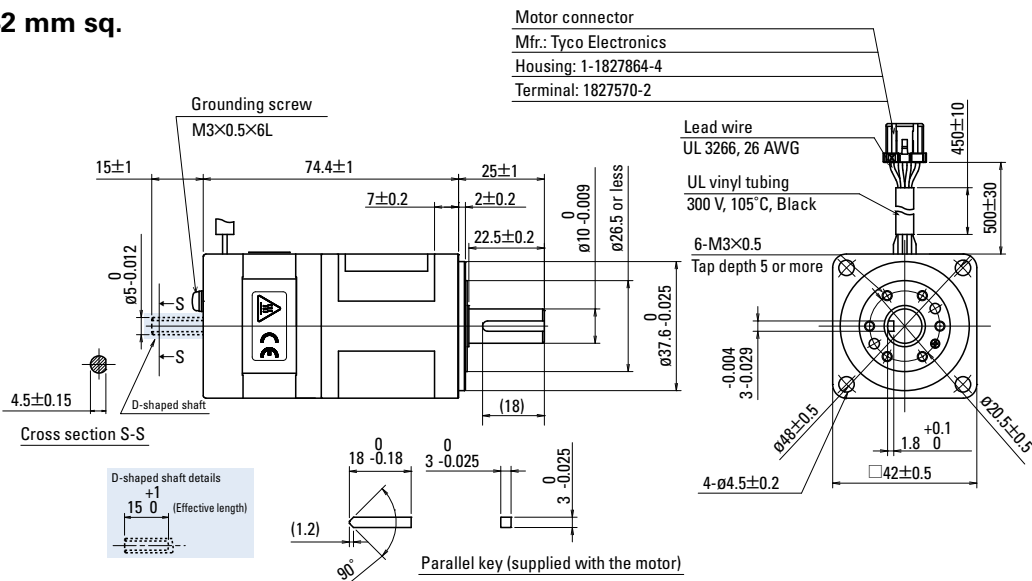

Motor model no.	
Single shaft	Dual shaft
SM5421-32HXJ40	SM5421-32HXJ10
SM5421-32HXL40	SM5421-32HXL10
SM5421-32HXM40	SM5421-32HXM10

Stepping Motor Dimensions Unit: mm

EM brake models

42 mm sq.

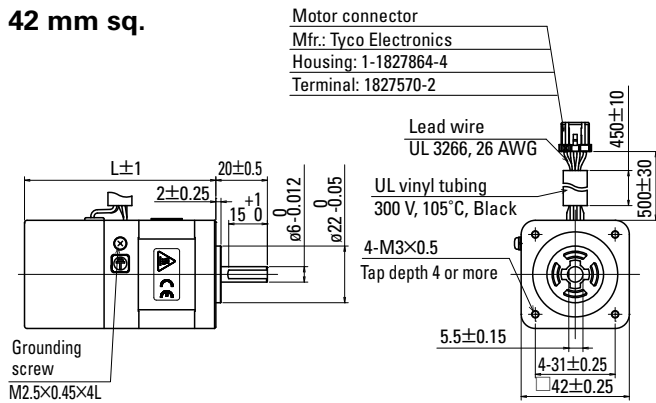

Motor model no.		Motor length (L)
Single shaft	Dual shaft	
SM5421-32XB40	—	68
SM5422-32XB40	—	74.3
SM5423-32XB40	—	82

60 mm sq.

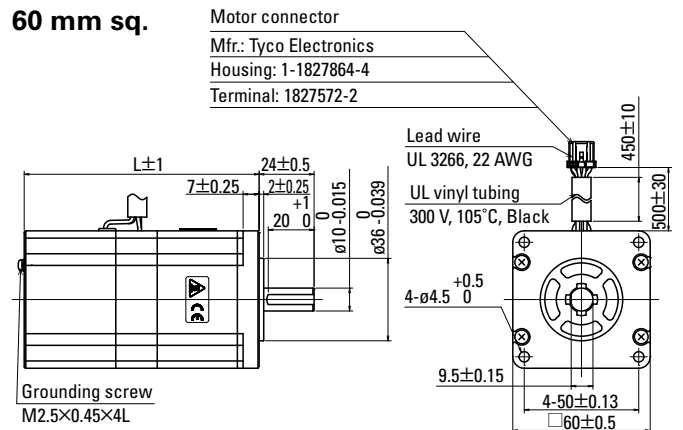

Motor model no.		Motor length (L)
Single shaft	Dual shaft	
SM5601-72XB40	—	91.4
SM5602-72XB40	—	102.6
SM5603-72XB40	—	131.3

86 mm sq.

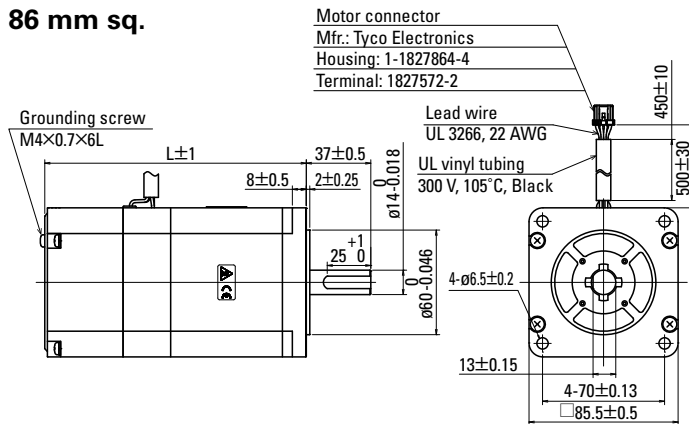

Motor model no.		Motor length (L)
Single shaft	Dual shaft	
SM5861-72XB40	—	119.5
SM5862-72XB40	—	150
SM5863-72XB40	—	180.4

Encoder-mounted models

42 mm sq.

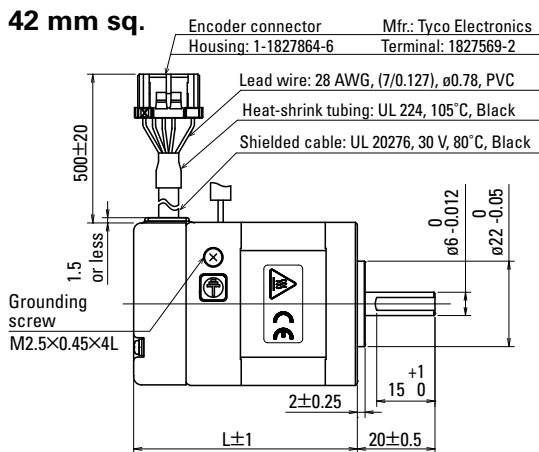

Motor model no.		Motor length (L)
Single shaft	Dual shaft	
SM5421-32XE40	—	51.3
SM5422-32XE40	—	57.6
SM5423-32XE40	—	65.3

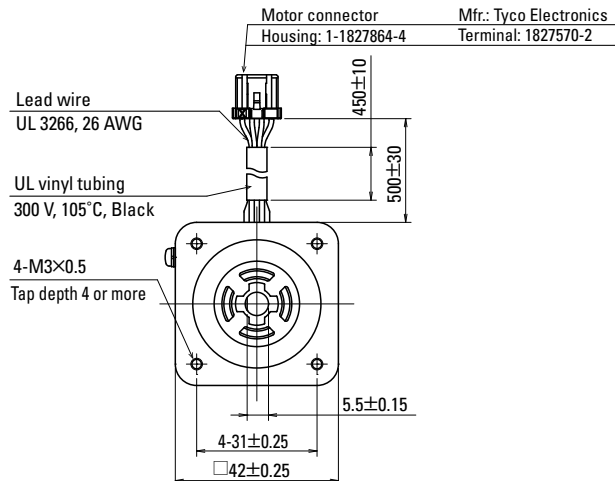

Encoder-mounted models

60 mm sq.

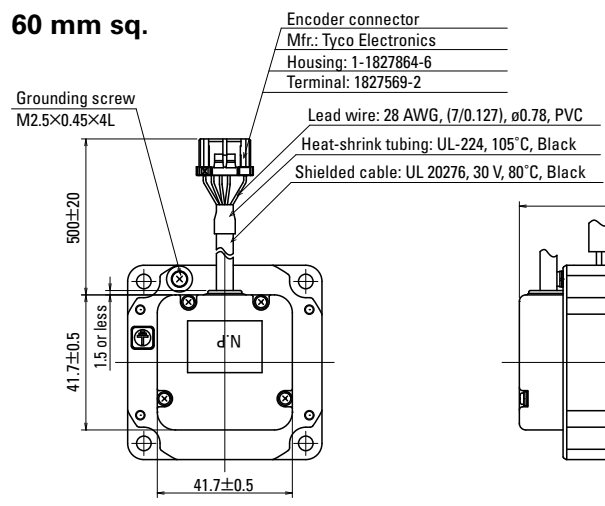

Motor connector
Mfr.: Tyco Electronics
Housing: 1-1827864-4
Terminal: 1827572-2

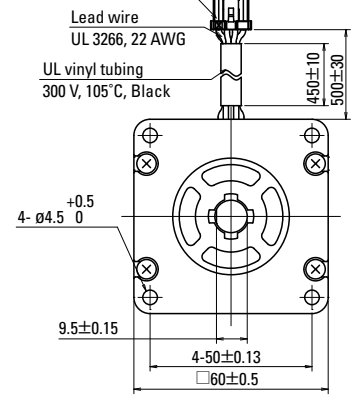

Motor model no.		Motor length (L)
Single shaft	Dual shaft	
SM5601-72XE40	—	65.6
SM5602-72XE40	—	76.8
SM5603-72XE40	—	105.5

86 mm sq.

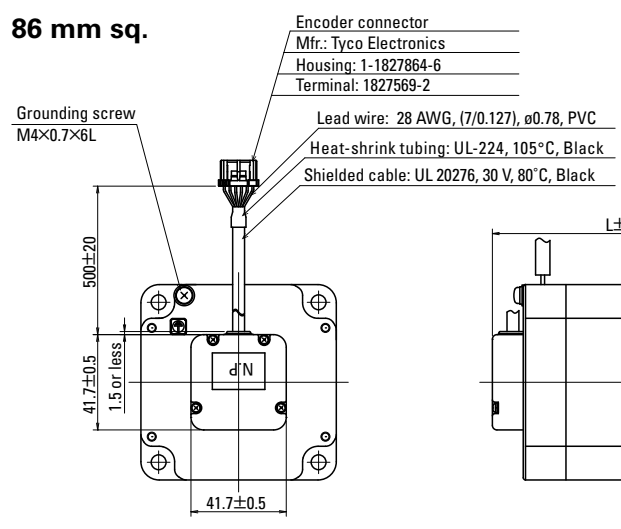

Motor connector
Mfr.: Tyco Electronics
Housing: 1-1827864-4
Terminal: 1827572-2

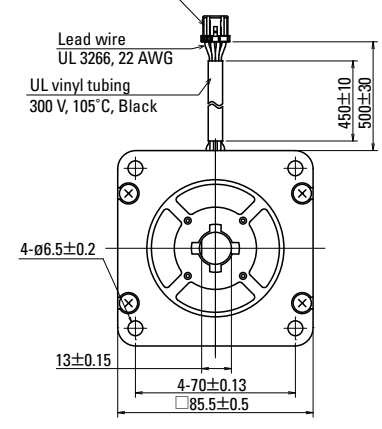

Motor model no.		Motor length (L)
Single shaft	Dual shaft	
SM5861-72XE40	—	79.5
SM5862-72XE40	—	110
SM5863-72XE40	—	140.5

General Specifications of Stepping Motors

Motor model no.	SM542□	SM560□	SM586□
Operation type	Continuous operation (S1)		
Operating ambient temperature	-10 to +40°C (0 to +40°C for harmonic gear models)		
Storage temperature	-20 to +60°C		
Operating ambient humidity	95% RH or less: Below 40°C (non-condensing)		
Storage humidity	95% RH or less: Below 40°C, 57% RH or less: Below 50°C, 35% RH or less: Below 60°C (non-condensing)		
Operating altitude	Up to 1000 m above sea level		
Vibration resistance	Frequency 10 to 500 Hz, amplitude 1.52 mm (10 to 70 Hz), vibration acceleration 150 m/s ² (70 to 500 Hz), sweep time 15 min/cycle, a total of 12 tests in both opposite directions for each of X, Y, and Z axes.		
Shock resistance	Acceleration 500 m/s ² , duration 11 ms, half sine wave, tested 3 times in both directions for each X, Y, and Z axis for a total of 18 times		
Thermal class	F (+155°C)		
Dielectric strength	1500 VAC for 1 minute (between motor winding and frame)		
Insulation resistance	100 MΩ min. at 500 VDC (between motor winding and frame)		
Protection rating	IP40		
Winding temperature rise	85 K or less (based on our own standard)		
Positional accuracy	±0.09°		
Thrust play ⁽¹⁾	0.075 mm or less (With a 5 N load)	0.075 mm or less (With a 10 N load)	0.075 mm or less (With a 10 N load)
Radial play ⁽²⁾	0.025 mm or less (With a 5 N load)	0.025 mm or less (With a 5 N load)	0.025 mm or less (With a 5 N load)
Shaft runout	0.025 mm	0.025 mm	0.025 mm
Concentricity of motor shaft and fitting part	ø0.05 mm	ø0.075 mm	ø0.075 mm
Perpendicularity of mounting surface and motor shaft	0.1 mm	0.1 mm	0.15 mm
Motor mounting orientation	Can be installed vertically or horizontally.		

(1) Thrust play: Maximum shaft position displacement when a load is exerted in a direction parallel to the motor shaft.

(2) Radial play: Maximum shaft position displacement when a load is exerted in a direction perpendicular to the motor shaft.
Load is exerted on the point 1/3 the shaft length from the shaft end.

Safety standards

CE marking for EU Directive	Directive	Standards	
	Low Voltage Directive 2014/35/EU	IEC 60034-1, IEC 60034-5	
	RoHS Directive 2011/65/EU	EN IEC 63000: 2018	
UKCA marking for Great Britain (UK Conformity Assessed Marking)	Electrical Equipment (Safety) Regulations 2016	IEC 60034-1, IEC 60034-5	
	RoHS Regulations 2012	EN IEC 63000: 2018	
UL	Classification	Standards	File no.
	UL	UL 1004-1, UL 1004-6	E179832 (PRHZ2)
	cUL ⁽³⁾	CSA C22.2 No.100	E179832 (PRHZ8)

(3) SM542□ type is not cUL compliant.

Internal Wiring and Rotational Directions

Internal wiring

Wiring: New pentagon configuration

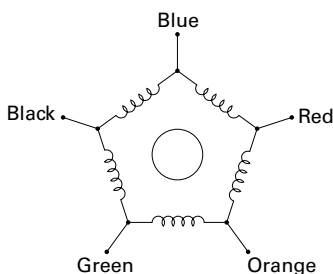

Direction of motor rotation

When excited by a direct current in the order shown below, the direction of rotation is clockwise as viewed from the output shaft side.

Note: This is in the case of standard models and EM brake models.

Contact us for geared models as some of them have different direction of motor rotation.

		Excitation sequence									
		1	2	3	4	5	6	7	8	9	10
Lead color	Blue			+	+	+			-	-	-
	Red	-	-			+	+	+			-
	Orange		-	-	-			+	+	+	
	Green	+			-	-				+	+
	Black	+	+	+			-	-	-		

Driver Dimensions Unit: mm

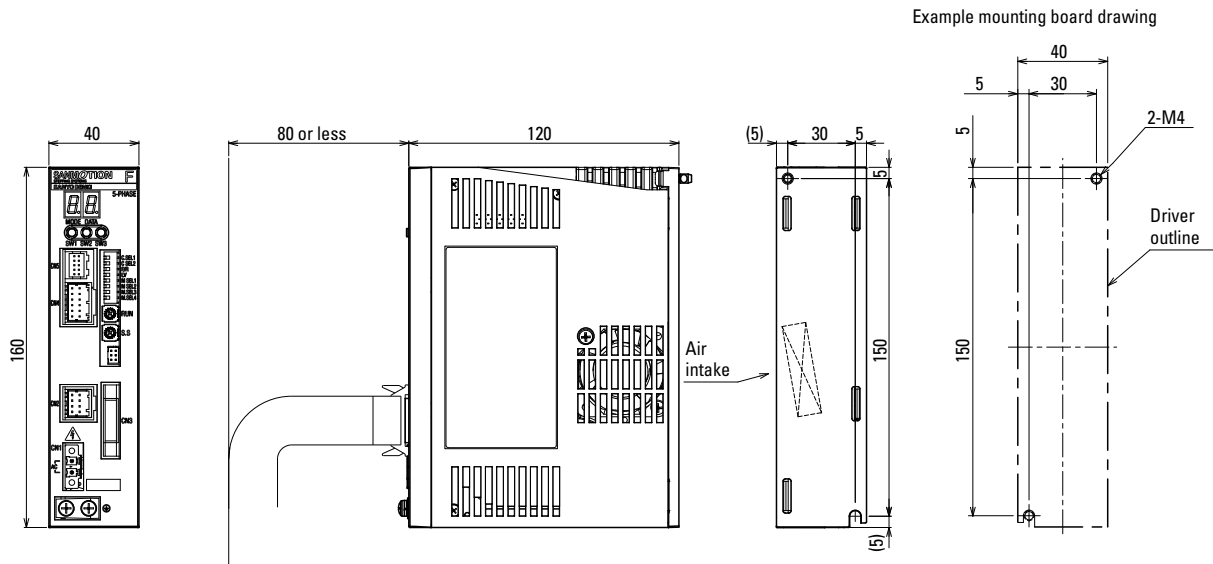

Driver Specifications

General specifications

Model no.		F5PAA035P100	F5PAA075P100	F5PAB035P100	F5PAB075P100
Input voltage		Single-phase 100 to 120 VAC (+10, -15%), 50/60 Hz		Single-phase 200 to 240 VAC (+10, -15%), 50/60 Hz	
Input current		2 A	4 A	1.5 A	3 A
Basic specifications	Environment	Protection class	Class I		
		Operating environment	Installation category (Overvoltage category): II, pollution level: 2		
		Operating ambient temperature	0 to +55°C		
		Storage temperature	-20 to +70°C		
		Operating ambient humidity	90% RH or less (non-condensing)		
		Storage humidity	90% RH or less (non-condensing)		
		Operating altitude	Up to 1000 m above sea level		
		Vibration resistance	5 m/s ² freq. range 10 to 55 Hz tested for 2 hours in each X, Y and Z-axis directions		
		Shock resistance	20 m/s ²		
		Dielectric strength	1500 VAC for 1 minute (between power input terminal and chassis)		
Insulation resistance	10 MΩ min. at 500 VDC (between power input terminal and chassis)				
Mass		0.65 kg			
Functions	Mode selection	Control mode, pulse input mode, low-vibration mode, motor selection, step angle, operating current			
	Protection functions	Overvoltage protection, power supply undervoltage protection, overheat detection, overcurrent protection			
	LED indicators	Status display, alarm display			
I/O signal	Command pulse input signal	Open collector terminal	Photocoupler input method; input resistance: 470 Ω High-level input signal voltage: 4.5 to 5.5 V, Low-level input signal voltage: 0 to 0.5 V. Maximum input frequency 400 kpulse/s		
		Line driver terminal	Photocoupler input method; input resistance: 150 Ω High-level input signal voltage: 3.0 to 3.5 V, Low-level input signal voltage: 0 to 0.5 V. Maximum input frequency 400 kpulse/s		
	Input signal	Photocoupler input method; input resistance: 2.2 k Ω High-level input signal voltage: 4.75 to 26.4 V, Low-level input signal voltage: 0 to 1.0 V			
	Output signal	Open-collector output through photocoupler, V _{ceo} : 4.75 to 26.4 V, I _c : 10 mA or less			

Safety standards

CE (TÜV)	UKCA		
Directive	Directive	Standards	
Low Voltage Directive	Electrical Equipment (Safety) Regulations 2016	EN 61800-5-1	
EMC Directive	Electromagnetic Compatibility Regulations 2016	EN 61800-3	
		EN 61000-6-2	
		EN 61000-6-4	
RoHS	Directive	Standards	
	RoHS Directive 2011/65/EU	EN 63000:2018	
UL	Classification	Standards	File no.
	UL	UL 508C	E179775
	UL for Canada (cUL)		

Note 1: Actual EMC levels vary depending on the configuration of the users' control panel in customers' systems, to which a driver and stepping motor are built in, and the placement layout of other electrical devices and wiring. EMC noise solution parts such as noise filters and toroidal type ferrite cores may be required in some cases.

Note 2: Validation test of drivers was performed as per Low-Voltage and EMC Directives at TÜV (TÜV product service) for self-declaration of CE/UKCA marking.

Driver Part Names and Functions

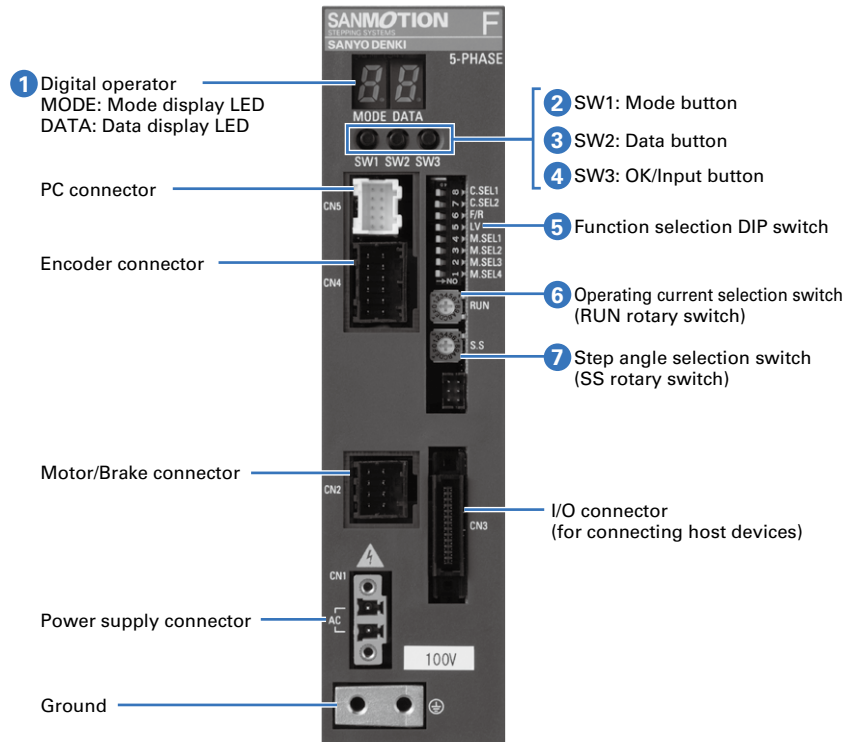

1 Digital operator

Specific parameter settings and jog operation are available.

• MODE: Mode display LED

Displays a number/alphabet indicating the current mode.

MODE	Functions	DATA: Data display LED	Factory setting
0	Driver status display	Displays driver status	—
4	Current settings at rest	0 to F (100% to 25%)	A (50%)
5	Step division mode settings	2: 2-phase, 5: 5-phase	5 (5-phase)
6	Step Division 2 setting	0 to F (same as SS rotary switch)	0 (1 subdivision)
7	Excitation selection	0: Excitation origin, 1: Excitation phase at power-off (Excitation origin)	0 (Excitation origin)
8	JOG operation speed	1 to F (100 min ⁻¹ /LSB)	1 (100 min ⁻¹)
9	JOG operation	—	—
A	Alarm codes display	Displays alarm codes	—
B	Settling control	0: Settling control disabled, 1 to F: Small effect to large effect	0 (disabled)

• DATA: Data display LED

Displays monitor and parameter setting values. If the currently displayed parameter setting value is different from the current setting value, it will blink.

2 SW1: Mode button

3 SW2: Data button

4 SW3: OK/Input button

Used for each setting together with the digital operator. For details on the settings, please refer to the Instruction Manual. The Instruction Manual is available for download from the Product Information on our website.

5 Function selection DIP switch

Sets the control mode, pulse input mode, low-vibration mode, and motor selection.

SW No.	Symbol	Functions
8	C.SEL1	Control mode selection
7	C.SEL2	
6	F/R	Pulse input mode selection
5	LV	Low-vibration mode
4	M.SEL1	Motor selection
3	M.SEL2	
2	M.SEL3	
1	M.SEL4	

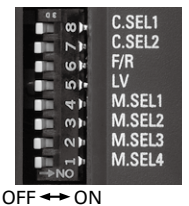

• Change the DIP switch settings while the power supply is off. Settings cannot be changed after the power is turned on.

• Factory settings: LV set to ON and all others set to OFF.

6 Operating current selection switch (RUN rotary switch)

Sets the operating current.

Dial	0	1	2	3	4	5	6	7
Motor current (%)	100	95	90	85	80	75	70	65
Dial	8	9	A	B	C	D	E	F
Motor current (%)	60	55	50	45	40	35	30	25

• The factory setting is F (25%).

7 Step angle selection switch (SS rotary switch)

Sets the Step Division 1.

5-phase mode: Digital operator MODE 5 is set to 5.				2-phase mode: Digital operator MODE 5 is set to 2.			
SS settings	Microsteps	Resolution	Step angle	SS settings	Microsteps	Resolution	Step angle
0	1	500	0.72°	0	0.4	200	1.8°
1	2	1000	0.36°	1	0.8	400	0.9°
2	2.5	1250	0.288°	2	1.6	800	0.45°
3	4	2000	0.18°	3	2	1000	0.36°
4	5	2500	0.144°	4	3.2	1600	0.225°
5	8	4000	0.09°	5	4	2000	0.18°
6	10	5000	0.072°	6	6.4	3200	0.1125°
7	20	10000	0.036°	7	10	5000	0.072°
8	25	12500	0.0288°	8	12.8	6400	0.05625°
9	40	20000	0.018°	9	20	10000	0.036°
A	50	25000	0.0144°	A	25.6	12800	0.028125°
B	80	40000	0.009°	B	40	20000	0.018°
C	100	50000	0.0072°	C	50	25000	0.0144°
D	125	62500	0.00576°	D	51.2	25600	0.0140625°
E	200	100000	0.0036°	E	100	50000	0.0072°
F	250	125000	0.00288°	F	102.4	51200	0.00703125°

• The factory setting is "1".

• Step Divisions 1 and 2 can be switched with the step angle selection (SSEL) signal.

• Step Division 2 can be set in MODE 6 of the digital operator.

Driver Part Names and Functions

Control mode selection

Select the stepping motor control mode.

SW8 C.SEL1	SW7 C.SEL2	Control mode
OFF	OFF	Normal mode
ON	OFF	Analysis mode
OFF	ON	Reserved (do not set a value)
ON	ON	Reserved (do not set a value)

- Normal mode
Controls general stepping motor operations.
- Analysis mode
Encoder-mounted models can perform step-out detection, speed monitoring, and current position monitoring.

Pulse input mode selection

Pulse input mode can be selected.

SW6 F/R	Pulse input mode
OFF	2-input mode (CW/CCW pulse)
ON	1-input mode (pulse/direction)

Low-vibration mode

Motors can smoothly operate even at low-resolution settings.

SW5 LV	Operation
OFF	Microstepping mode
ON	Low-vibration mode

Low-vibration mode performs operational processes for the drive pulse inside the driver. Therefore, motor movement will be delayed by 1 pulse for each input pulse.

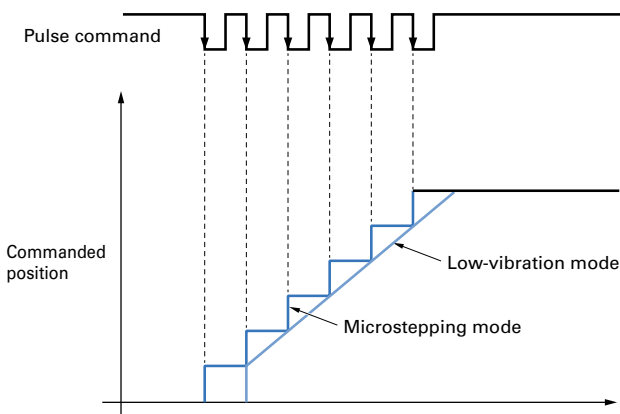

Motor selection

Select a motor to be used with the driver.

Driver model no.: F5PAA035P100, F5PAB035P100

SW4 M.SEL1	SW3 M.SEL2	SW2 M.SEL3	SW1 M.SEL4	Motor model no.
OFF	OFF	OFF	OFF	SM5421-32□□
ON	OFF	OFF	OFF	SM5422-32□□
OFF	ON	OFF	OFF	SM5423-32□□
Other settings				Reserved

Driver model no.: F5PAA075P100, F5PAB075P100

SW4 M.SEL1	SW3 M.SEL2	SW2 M.SEL3	SW1 M.SEL4	Motor model no.
ON	OFF	ON	OFF	SM5601-72□□
OFF	ON	ON	OFF	SM5602-72□□
ON	ON	ON	OFF	SM5603-72□□
OFF	OFF	OFF	ON	SM5861-72□□
ON	OFF	OFF	ON	SM5862-72□□
OFF	ON	OFF	ON	SM5863-72□□
Other settings				Reserved

Connections and Signals

External wiring diagram

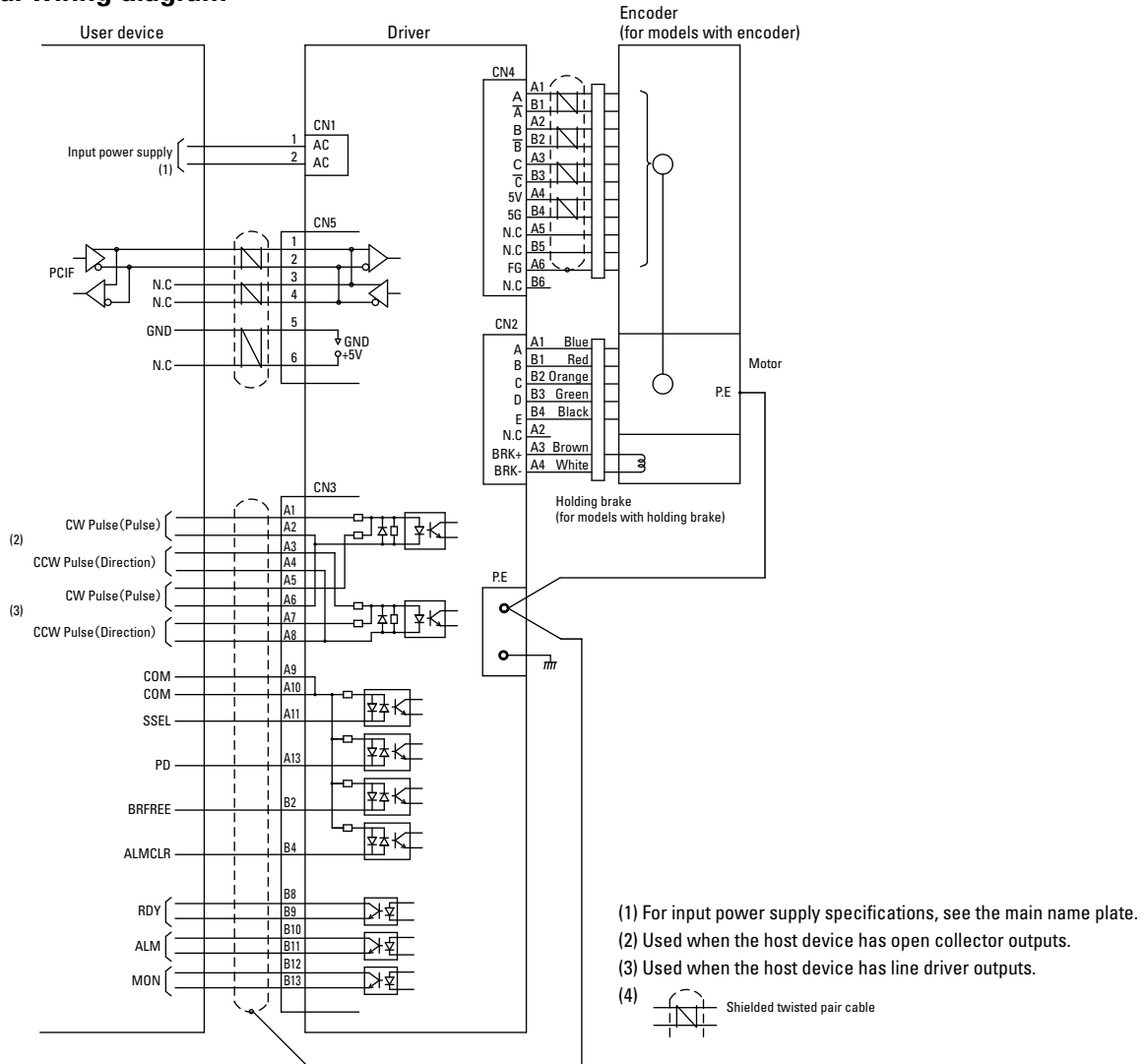

Wiring

Connector model and compatible wires

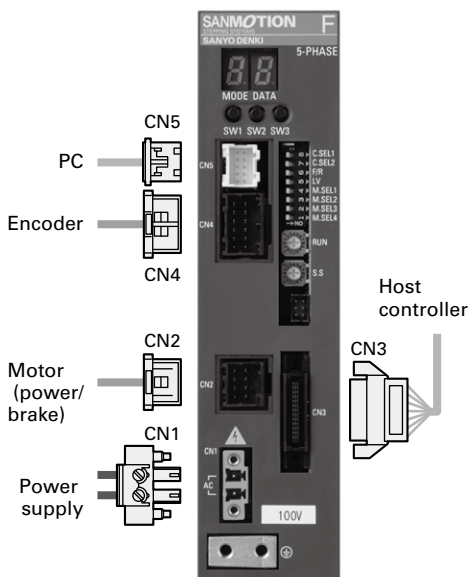

Use	Code	Name	Model	Compatible wires	Wire length	Manufacturer
Power supply	CN1	Socket (driver side)	MC 1,5/ 2-GF-5,08	18 AWG	3 m max.	Phoenix Contact K.K.
		Plug	MC 1,5/ 2-STF-5,08	Discrete wire		
Power/Brake (for 60, 86 mm sq.)	CN2	Tab header (driver side)	1-1827876-4	18 to 22 AWG	20 m max.	Tyco Electronics Japan G.K.
		Recessed housing	1-1827864-4	Discrete wire ⁽¹⁾		
		Recessed contact	1827572-2			
Power/Brake (for 42 mm sq.)	CN2	Tab header (driver side)	1-1827876-4	22 to 26 AWG	20 m max.	Tyco Electronics Japan G.K.
		Recessed housing	1-1827864-4	Discrete wire ⁽²⁾		
		Recessed contact	1827570-2			
Input/Output	CN3	Plug (driver side)	8831E-026-170LD-F	28 AWG (7/0.127)	2 m max.	KEL CORPORATION
		Receptacle	8822E-026-171D			
Encoder	CN4	Tab header (driver side)	1-1827876-6	22 to 28 AWG	20 m max.	Tyco Electronics Japan G.K.
		Recessed housing	1-1827864-6	Shielded twisted pair		
		Recessed contact	1827570-2			
Communications	CN5	Connector header through-hole, right angle (driver side)	S10B-PADSS-1GW	24 to 28 AWG	2 m max.	J.S.T.
		Housing	PADP-10V-1-S	Shielded twisted pair		
		Contact	SPH-002GW-P0.5S			

(1) When extending the power cable more than 3 m, we recommend using 18 or 20 AWG wire.
 (2) When extending the power cable more than 3 m, we recommend using a wire thicker than 22 AWG.
 (When using 18 or 20 AWG wire, use a recessed contact 1827572-2)

Wiring

Wiring

Power supply connector (CN1)

Pin no.	Symbol	Signal
1	AC	AC
2	AC	AC

Note 1: The power input cable, motor power cable, I/O cable, or encoder cable must not be passed through the same duct.

Note 2: Make sure to connect or disconnect power input cables 10 minutes after turning power off. Failure to follow this may cause damage on drivers.

Note 3: For details on input current, inrush current, and leakage current, refer to the Instruction Manual and select appropriate breaker, electromagnetic contactor, and noise filter.

Power connector (CN2)

Pin no.	Signal	Lead color
A1	Power phase A	Blue
B1	Power phase B	Red
A2	—	—
B2	Power phase C	Orange
A3	Holding brake +	Brown
B3	Power phase D	Green
A4	Holding brake -	White
B4	Power phase E	Black

Note 1: The color of the lead wires on the holding brake varies with the polarity. Holding brakes without polarity use the same lead wire color.

Note 2: The power supply for the holding brake is inside the driver. The holding brake is automatically controlled by the driver.

Note 3: Make sure to connect or disconnect power input cables 10 minutes after turning the power off. Failure to follow this may cause damage on drivers.

I/O signal connector (CN3)

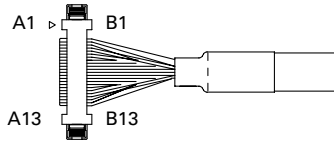

Pin no.	Signal	Functions	Lead color	Mark display	Mark color
A1	CW Pulse / Pulse	CW pulse (pulse) (for open collector)	Orange		Red
A2	—	—	—		Black
A3	CCW Pulse / DIR	CCW pulse (direction) (for open collector)	Gray		Red
A4	—	—	—		Black
A5	CW Pulse / Pulse	CW pulse (pulse) (for line driver)	White		Red
A6	—	—	—		Black
A7	CCW Pulse / DIR	CCW pulse (direction) (for line driver)	Yellow		Red
A8	—	—	—		Black
A9	COM	—	—		Red
A10	COM	Input common	Pink		Black
A11	SSEL	Step angle selection input	Orange		Red
A12	—	—	—		Black
A13	PD	Power down input	Gray		Red
B1	—	—	—	Black	
B2	BRFREE	Brake free input	White	Red	
B3	—	—	—	Black	
B4	ALMCLR	Alarm clear input	Yellow	Red	
B5	—	—	—	Black	
B6	—	—	—	Red	
B7	—	—	—	Black	
B8	RDY+	Operation ready output	Orange	Red	
B9	RDY-			Black	
B10	ALM+	Alarm output	Gray	Red	
B11	ALM-			Black	
B12	MON+			Phase origin monitor output	White
B13	MON-	Black			

Note: Setup software and a connection unit are required to set the I/O signal logic. Refer to the Instruction Manual when preparing.

Encoder connector (CN4)

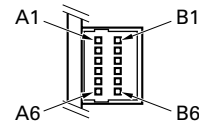

Pin no.	Signal	Lead color
A1	Phase A +	Blue
B1	Phase A -	Brown
A2	Phase B +	Green
B2	Phase B -	Purple
A3	Phase Z +	White
B3	Phase Z -	Yellow
A4	VCC	Red
B4	GND	Black
A5	—	—
B5	—	—
A6	FG	Black
B6	—	—

Communication connector (CN5)

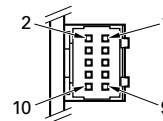

Pin no.	Signal	Lead color
1	A	Yellow
2	B	White
3	(A)	—
4	(B)	—
5	GND	Black
6	(VCC)	—
7	—	—
8	—	—
9	—	—
10	—	—

Pulse Command Input

Connection example

Connection to line driver output	Connection to open collector output
Pulse crest value High-level: 3.0 to 3.5 V Low-level: 0 to 0.5 V	Pulse crest value High-level: 4.5 to 5.5 V Low-level: 0 to 0.5 V
	<ul style="list-style-type: none"> If the peak voltage of the input signal exceeds 5.5 V, add an external current-limiting resistor R to limit the input current to around 7 mA. (Take the photocoupler forward voltage of 1.5 V into consideration.)

Pulse waveform

Maximum slewing frequency: 400 kpulse/s

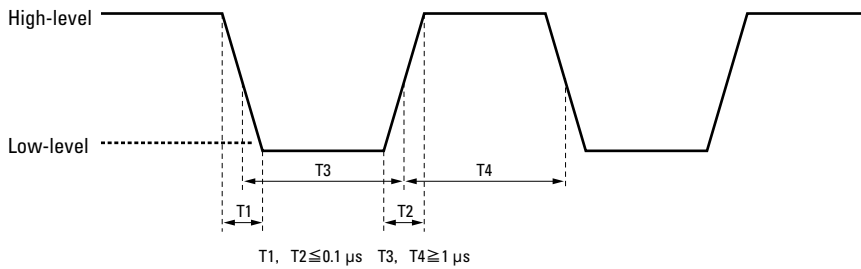

Note: Operation at the maximum speed is not available if the step division is high due to maximum slewing frequency.

Timing chart

2-input mode

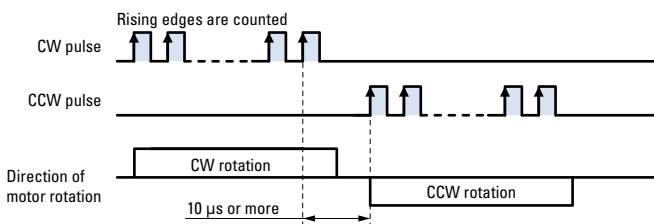

Note 1: Shaded areas indicate that the internal photocoupler is ON.

Note 2: CW rotation is clockwise and CCW rotation is counterclockwise as viewed from the motor flange side.

Note 3: Do not input CW/CCW pulses at the same time.

Note 4: The CW/CCW pulse switching time of "10 μs or more" is the operating time for the driver internal circuit, not the motor response time.

Set a time in which the motor can respond for actual operations.

Note 5: 1- and 2-input modes can be switched by DIP switch (F/R) settings.

1-input mode (rising edge operation)

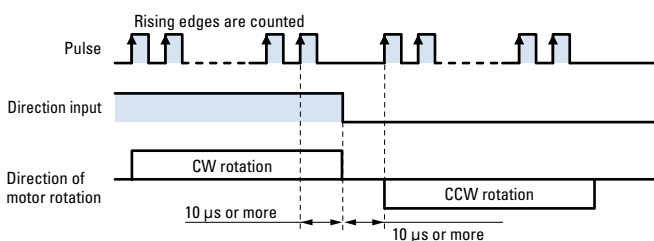

Note 1: Shaded areas indicate that the internal photocoupler is ON.

Note 2: CW rotation is clockwise and CCW rotation is counterclockwise as viewed from the motor flange side.

Note 3: The rotating direction switching time of "10 μs or more" is the operating time for the driver internal circuit, not the motor response time.

Set a time in which the motor can respond for actual operations.

Note 4: 1- and 2-input modes can be switched by DIP switch (F/R) settings.

Input signal

Connection example

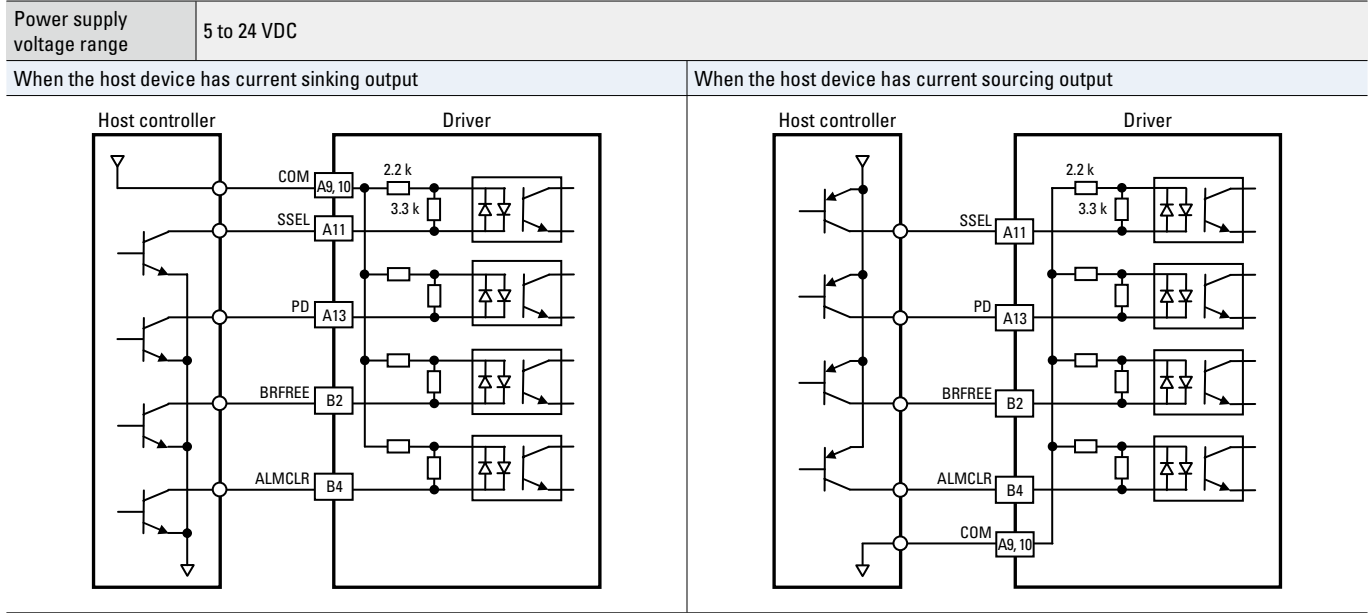

Output signal

Connection example

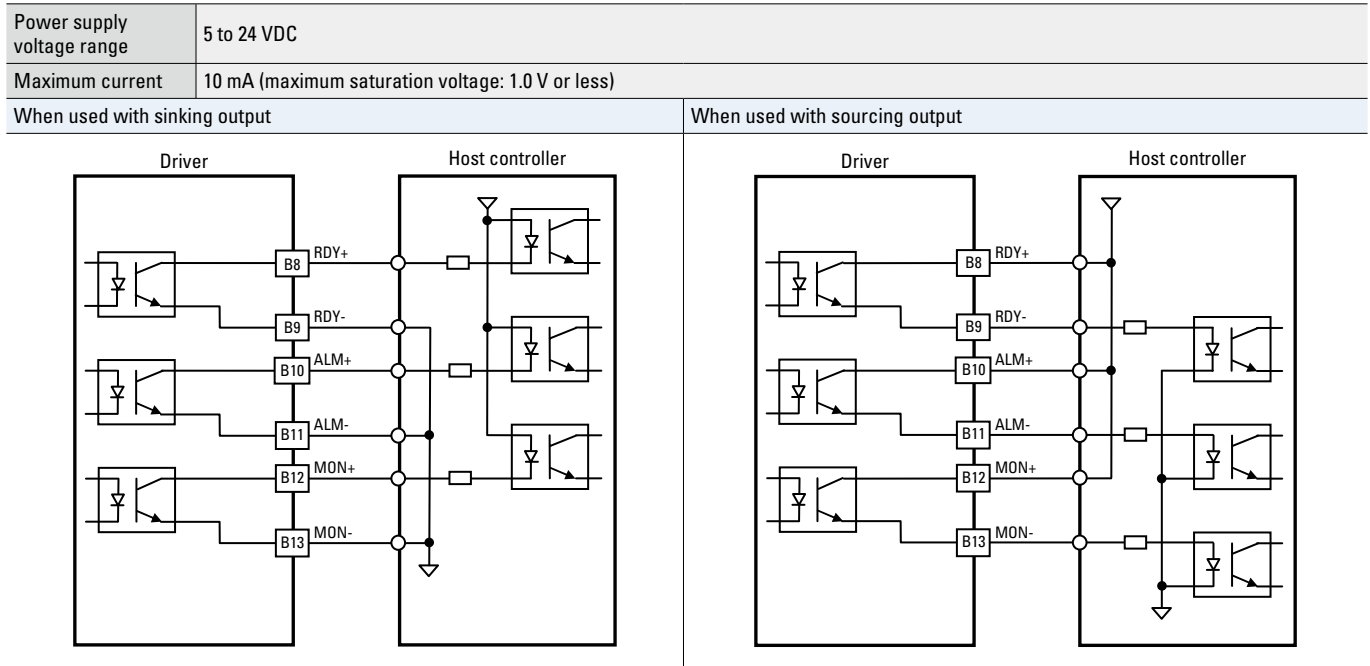

DC Input Drivers/Motors

High-power models

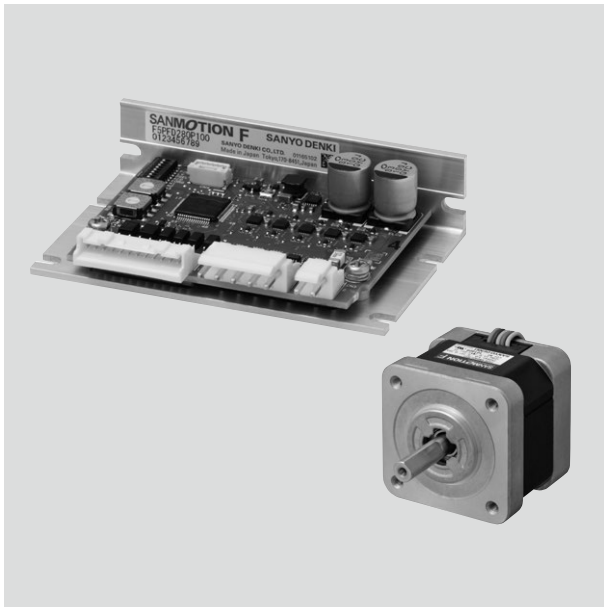

The high-power model is a high-output, high-performance driver. It can drive motors with high torque, contributing to shortening the cycle time of your equipment.

Lineup RoHS

Driver CE UK CA TUV c UL us K

Model: F5PFD280P100

Input voltage: 24 VDC

- The Instruction Manual is available for download from our website.

Motor New pentagon configuration

Motor size: 60 mm sq.

Options

Cable with connectors

Setup software connection unit

System Configuration

- ① Power supply cable (option)
- ② Motor cable (option)
- ③ I/O signal cable (option)
- ④ Setup software connection unit (option)

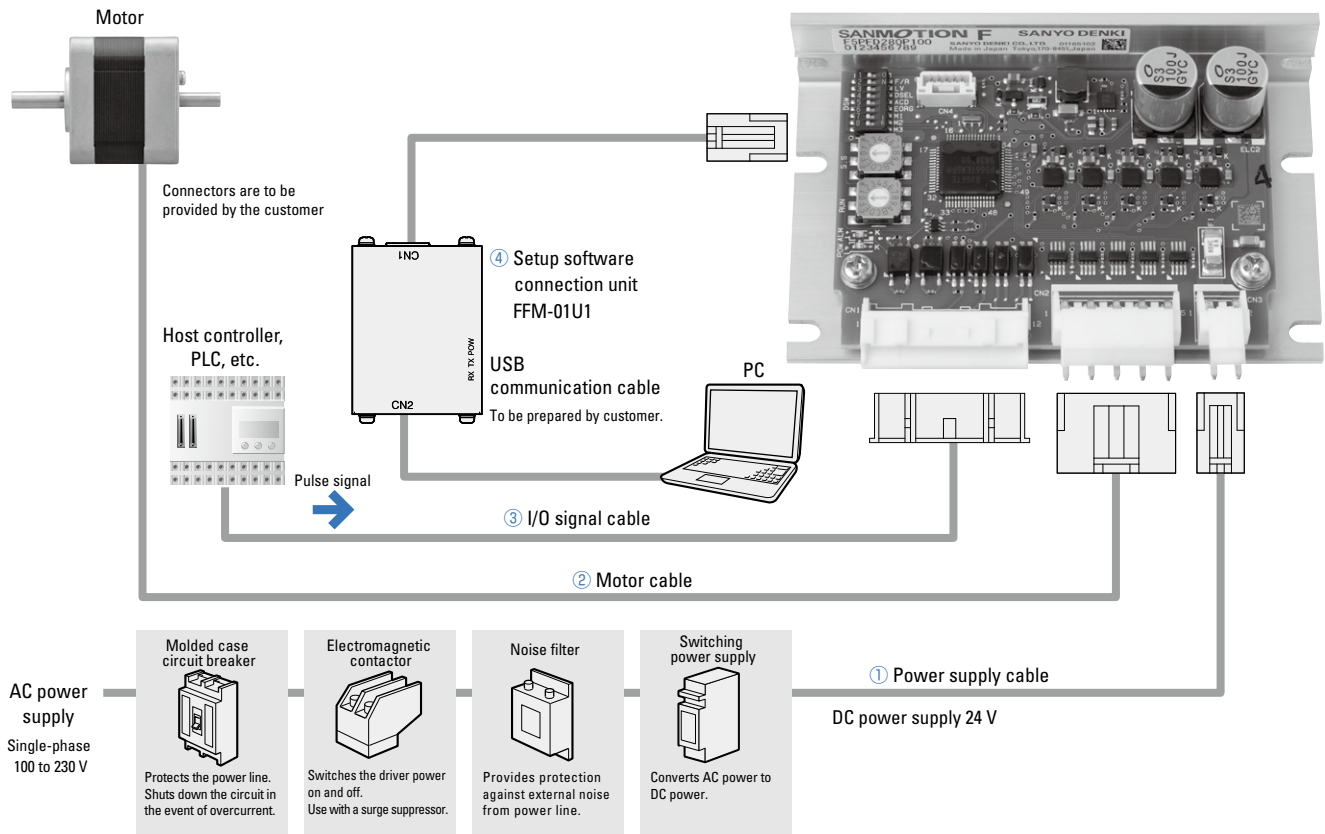

Combination Table

Full step angle: 0.72°

Motor						Driver		Options			
Model	Motor size	Single shaft	Dual shaft	Page		Model no.	Page	Power supply cable	Motor cable	I/O signal cable	Connection unit
				Specifications	Dimensions						
Standard models	60 mm sq.	SF5601-9251	SF5601-9221	p. 52, 54	p. 53	F5PFD280P100	p. 55	FC9P0010A	FC9M0010B	FC9S0010A	FFM-01U1
		SF5602-9251	SF5602-9221	p. 52, 54	p. 53	F5PFD280P100	p. 55				
		SF5603-9251	SF5603-9221	p. 52, 54	p. 53	F5PFD280P100	p. 55				

Note 1: Motors listed above are the lead type.

Note 2: Contact us for models with a gear, encoder, or brake.

Options

● **Cables with connectors** DC input motors are the lead type without connectors. Motor-side connectors and connection units need to be prepared by customers.

Power supply cable (Model no.: FC9P0010A)

Pin no.	Color
1	White
2	Black

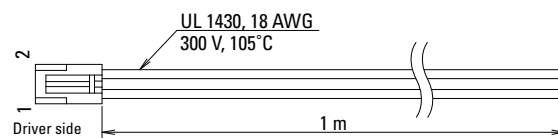

Motor cable (Model no.: FC9M0010B)

Pin no.	Color
1	Blue
2	Red
3	Orange
4	Green
5	Black

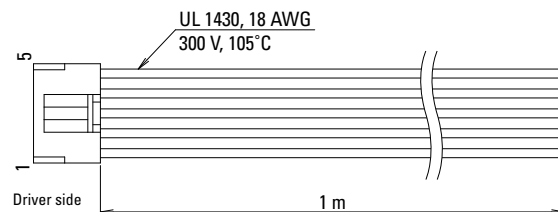

I/O signal cable (Model no.: FC9S0010A)

Pin no.	Color
1	Blue
2	
3	
4	
5	
6	
7	
8	
9	
10	
11	
12	

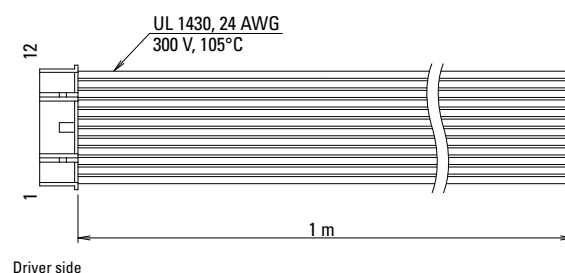

● **Setup software connection unit** (Model no.: FFM-01U1)

A set of a communication converter (FFM-01) and a communication cable (between converter and driver)

Note: The USB cable to connect the FFM-01 to the PC should be provided by the customer as shown in the table below.

Interface	
PC side	USB Type-A
FFM-01 connector	USB 2.0 Type-B

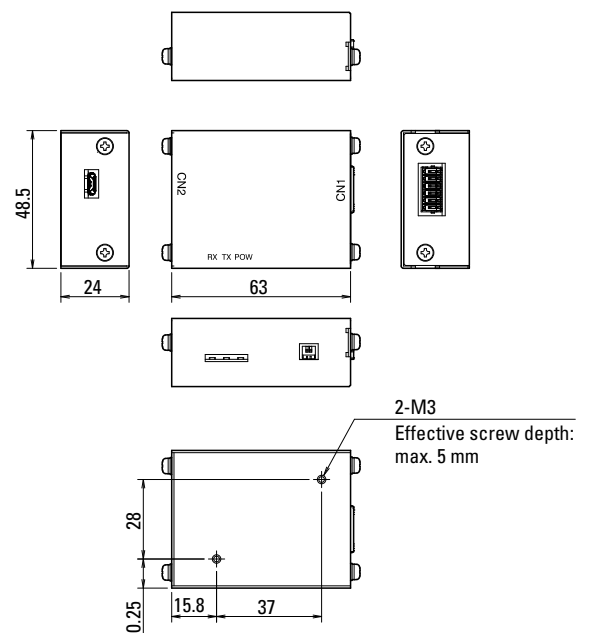

Standard models DC input driver (Model no.: F5PFD280P100) + Standard motor

RoHS

Full step angle: 0.72°

Motor size		60 mm sq.		
Motor length		49 mm	60 mm	89 mm
Single shaft	Motor model no.	SF5601-9251	SF5602-9251	SF5603-9251
Dual shaft	Motor model no.	SF5601-9221	SF5602-9221	SF5603-9221
Holding torque	N·m or more	0.5	0.83	1.55
Rotor inertia	$\times 10^{-4}$ kg·m ²	0.2	0.31	0.6
Rated current	A/phase	2.8	2.8	2.8
Motor mass ⁽¹⁾	kg	0.62	0.8	1.27
Allowable thrust load	N	20	20	20
Allowable radial load ⁽²⁾	N	102	97	85

(1) For the driver mass, see ▶ p. 55
 (2) Load is exerted to the shaft end.

Characteristics

With rubber coupling used Pull-out torque — Input current (with no load) - - - Input current (with load) ····· fs: Maximum starting frequency with no load ●

SF5601-9251 SF5601-9221

Winding current: 2.8 A/phase

24 VDC

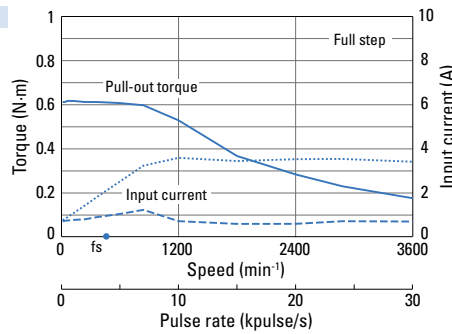

SF5602-9251 SF5602-9221

Winding current: 2.8 A/phase

24 VDC

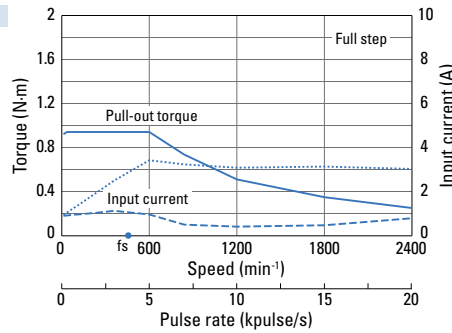

SF5603-9251 SF5603-9221

Winding current: 2.8 A/phase

24 VDC

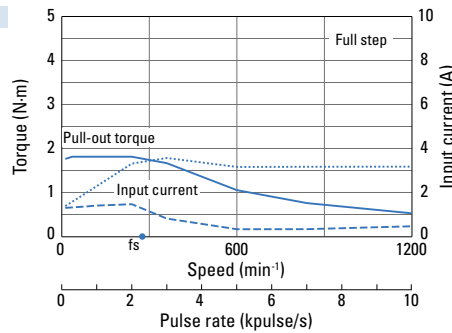

General Specifications of Stepping Motors

Motor model no.	SF560□
Operation type	—
Operating ambient temperature	-10 to + 50°C
Storage temperature	-20 to +65°C
Operating ambient humidity	20 to 90% RH (non-condensing)
Storage humidity	5 to 95% RH (non-condensing)
Operating altitude	Up to 1000 m above sea level
Vibration resistance	Frequency 10 to 500 Hz, amplitude 1.52 mm (10 to 70 Hz), vibration acceleration 150 m/s ² (70 to 500 Hz), sweep time 15 min/cycle, a total of 12 tests in both opposite directions for each of X, Y, and Z axes.
Shock resistance	Acceleration 500 m/s ² , duration 11 ms, half sine wave, tested 3 times in both directions for each X, Y, and Z axis for a total of 18 times
Thermal class	B (+130°C)
Dielectric strength	1500 VAC for 1 minute (between motor winding and frame)
Insulation resistance	100 MΩ min. at 500 VDC (between motor winding and frame)
Protection rating	IP40
Winding temperature rise ⁽¹⁾	80 K or less
Positional accuracy tolerance	± 0.09°
Thrust play ⁽²⁾	0.075 mm or less (With a 10 N load)
Radial play ⁽³⁾	0.025 mm or less (With a 5 N load)
Shaft runout	0.025 mm
Concentricity of motor shaft and fitting part	ø0.075 mm
Perpendicularity of mounting surface and motor shaft	0.1 mm
Motor mounting orientation	Can be installed vertically or horizontally.

(1) Conditions are based on our own standards.

(2) Thrust play: Maximum shaft position displacement when a load is exerted in a direction parallel to the motor shaft.

(3) Radial play: Maximum shaft position displacement when a load is exerted in a direction perpendicular to the motor shaft.
Load is exerted on the point 1/3 the shaft length from the shaft end.

Internal Wiring and Rotational Directions

Internal wiring

Wiring: New pentagon configuration

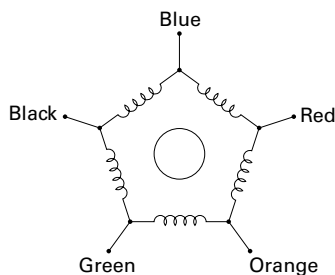

Direction of motor rotation

When excited by a direct current in the order shown below, the direction of rotation is clockwise as viewed from the output shaft side.

Note: This is in the case of standard models and EM brake models.

Contact us for geared models as some of them have different direction of motor rotation.

		Excitation sequence									
		1	2	3	4	5	6	7	8	9	10
Lead color	Blue			+	+	+			-	-	-
	Red	-	-			+	+	+			-
	Orange		-	-	-			+	+	+	
	Green	+			-	-	-			+	+
	Black	+	+	+			-	-	-		

Driver Dimensions Unit: mm

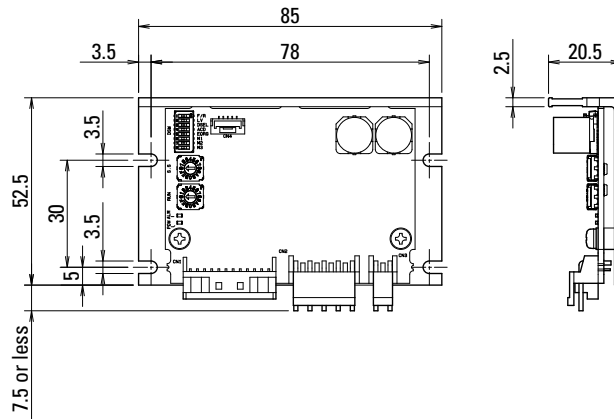

Driver Specifications

General specifications

Model no.		F5PFD280P100	
Basic specifications	Input voltage	24 VDC \pm 10%	
	Input current	5 A	
	Environment	Protection class	Class III
		Operating environment	Installation category (Overvoltage category): I (CE), pollution level: 2
		Operating ambient temperature	0 to +50°C
		Storage temperature	-20 to +70°C
		Operating ambient humidity	90% RH or less (non-condensing)
		Storage humidity	90% RH or less (non-condensing)
		Operating altitude	Up to 1000 m above sea level
		Vibration resistance	5 m/s ² freq. range 10 to 55 Hz tested for 2 hours in each X, Y and Z-axis directions
		Shock resistance	20 m/s ²
		Dielectric strength	700 VDC for 1 minute (between power input terminal and chassis)
	Insulation resistance	10 M Ω min. at 500 VDC (between power input terminal and chassis)	
Mass	0.06 kg		
Functions	Mode selection	Pulse input mode (1-/2-input mode), low-vibration mode (on/off), automatic current limiting (on/off), step division mode (2-/5-phase mode), initial excitation phase (excitation origin/excitation phase of last power off), motor selection, operating current, step angle	
	Protection functions	Power supply voltage monitoring, overheat detection, overcurrent protection, non-volatile memory checksum error, hardware error, motor wire breakage detection, command speed error, limit reached	
	LED indicators	Power supply, alarm/warning indicator	
	PC-based functions	Parameter customization, operating status monitoring	
I/O signal	Command pulse input signal	Photocoupler input method; input resistance: 260 Ω High-level input signal voltage: 4.0 to 5.25 V, Low-level input signal voltage: 0 to 0.5 V Between the high- and low-levels shall be 4.0 V or more. Maximum input frequency 400 kpulse/s	
	Power down input signal	Photocoupler input method; input resistance: 480 Ω High-level input signal voltage: 4.0 to 5.25 V, Low-level input signal voltage: 0 to 0.5 V	
	Step angle selection input signal	Photocoupler input method; input resistance: 480 Ω High-level input signal voltage: 4.0 to 5.25 V, Low-level input signal voltage: 0 to 0.5 V	
	Phase origin monitor output/ Alarm output signal	Open-collector output through photocoupler, collector-to-emitter voltage: 30 VDC or less Output current: 10 mA or less, Output saturation voltage: 1.0 V or less	

Safety standards

Safety standards		Standards
Directive	Directive	
UL/cUL standards	—	UL 61800-5-1 (File no. E179775)
KC mark (Korea Certification Mark)	—	KS C 9610-6-2, KS C 9610-6-4
CE marking for EU Directive	Low Voltage Directive 2014/35/EU	EN 61800-5-1
	Electromagnetic Compatibility Directive (2014/30/EU)	EN 61000-6-2 EN 61000-6-4
	RoHS Directive 2011/65/EU	EN IEC 63000: 2018
UKCA marking for Great Britain (UK Conformity Assessed Marking)	Electrical Equipment (Safety) Regulations 2016	EN 61800-5-1
	Electromagnetic Compatibility Regulations 2016	EN 61000-6-2 EN 61000-6-4
	RoHS Regulations 2012	EN IEC 63000: 2018

Driver Part Names and Functions

- 2 Function selection DIP switch (DSW)
- 3 Step angle selection switch (SS rotary switch)
- 1 Operating current selection switch (RUN rotary switch)
- 5 Alarm/Warning indicator LED (ALM)
- 4 Power supply monitoring LED (POW)

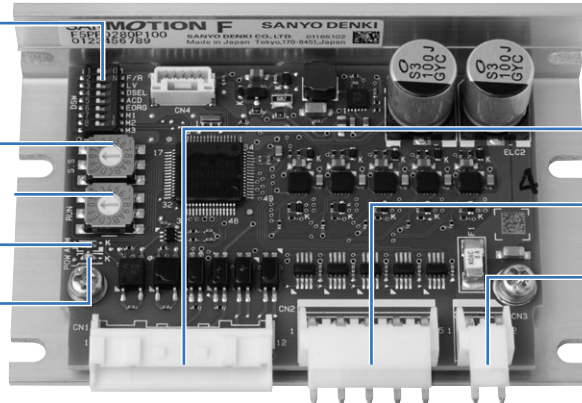

- I/O signal connector (CN1)
- Motor connector (CN2)
- Power supply connector (CN3)

1. Operating current selection switch (RUN rotary switch)

The value of the motor operating current can be set with a rotary switch.

Dial	0	1	2	3	4	5	6	7
Motor current (A)	2.8	2.66	2.52	2.38	2.24	2.1	1.96	1.82
Dial	8	9	A	B	C	D	E	F
Motor current (A)	1.68	1.54	1.4	1.26	1.12	0.98	0.84	0.7

- The factory setting is F (0.7 A).
Select the operating current after checking the rated current of the combination motor.
- If there are sufficient margins of motor torque, decreasing operating current value becomes effective for reduction in heat generation and vibration.
- Make sure to have sufficient operation margins before determining the motor current value to adjust operating current.

2. Function selection DIP switch (DSW)

Functions can be selected to suit your application.
Factory settings

F/R	1	OFF	Pulse input mode selection
LV	2	ON	Low-vibration mode
DSEL	3	OFF	Step division mode
ACD	4	ON	Auto-Current-Down
EORG	5	OFF	Excitation selection
M1	6	OFF	Motor selection
M2	7	OFF	
M3	8	OFF	

- First, do the settings of the motor to be combined with the driver.
- Make sure to turn off the power supply of the driver when changing the settings of the function selection DIP switch.

Combination motor settings

M1	M2	M3	Compatible motor model no.
OFF	OFF	OFF	Reserved
ON	OFF	OFF	Reserved
OFF	ON	OFF	Reserved
ON	ON	OFF	SF5601-92 □ 1
OFF	OFF	ON	SF5602-92 □ 1
ON	OFF	ON	SF5603-92 □ 1
OFF	ON	ON	Reserved
ON	ON	ON	Reserved

1. Pulse input mode selection (F/R)

Pulse input mode can be selected.

F/R	Pulse input mode
ON	1-input mode (CK, U/D)
OFF	2-input mode (CW, CCW)

2. Low-vibration mode selection (LV)

Motors can smoothly operate even at low-resolution settings such as full-step (1 subdivision) and half-step (2 subdivisions) modes.

LV	Operation mode
ON	Low-vibration mode enabled
OFF	Low-vibration mode disabled

3. Step division mode selection (DSEL)

Select the step angle selection switch (SS rotary switch) mode.

DSEL	Resolution mode
ON	2-phase mode: Operable as a normal 2-phase stepping system with a step angle of 1.8° to 0.00703125°.
OFF	5-phase mode: Operable as a normal 5-phase stepping system with a step angle of 0.72° to 0.00288°.

4. Auto-Current-Down (ACD)

This function reduces the motor current at rest (200 ms after the last pulse is applied), which is effective in suppressing heat generation and reducing the current consumption of the motor and driver.

ACD	Current at rest
ON	50% of driving current
OFF	100% of driving current

5. Excitation selection (EORG)

The excitation phase at the time of power-on is selected.

EORG	The excitation phase at power-on
ON	The excitation phase at power-off
OFF	Excitation origin

3. Step angle selection switch (SS rotary switch)

The number of subdivisions for a full step can be set with the rotary switch.

After selecting 2- or 5-phase mode by setting the "3" (DSEL) of the DSW (function selection DIP switch), set the step angle selection switch for the desired step angle.

5-phase mode: When the DSW's "3" (DSEL) is set to OFF				2-phase mode: When the DSW's "3" (DSEL) is set to ON			
SS	Microsteps	Resolution	Step angle	SS	Microsteps	Resolution	Step angle
0	1	500	0.72°	0	0.4	200	1.8°
1	2	1000	0.36°	1	0.8	400	0.9°
2	2.5	1250	0.288°	2	1.6	800	0.45°
3	4	2000	0.18°	3	2	1000	0.36°
4	5	2500	0.144°	4	3.2	1600	0.225°
5	8	4000	0.09°	5	4	2000	0.18°
6	10	5000	0.072°	6	6.4	3200	0.1125°
7	20	10000	0.036°	7	10	5000	0.072°
8	25	12500	0.0288°	8	12.8	6400	0.05625°
9	40	20000	0.018°	9	20	10000	0.036°
A	50	25000	0.0144°	A	25.6	12800	0.028125°
B	80	40000	0.009°	B	40	20000	0.018°
C	100	50000	0.0072°	C	50	25000	0.0144°
D	125	62500	0.00576°	D	51.2	25600	0.0140625°
E	200	100000	0.0036°	E	100	50000	0.0072°
F	250	125000	0.00288°	F	102.4	51200	0.00703125°

- The factory setting is "1".

4. Power supply monitoring LED (POW)

Lights up when the control and main circuit power supply are turned on.

5. Alarm/Warning indicator LED (ALM)

Flashes repeatedly when an alarm is generated.

LED indicators	Status
"ALM" blinks once repeatedly	Main power supply undervoltage
"ALM" blinks 2 times repeatedly	Main power supply overvoltage
"ALM" blinks 3 times repeatedly	Driver overheat
"ALM" blinks 4 times repeatedly	Overcurrent
"ALM" blinks 5 times repeatedly	Non-volatile memory checksum error
"ALM" blinks 6 times repeatedly	Hardware error
"ALM" blinks 7 times repeatedly	Motor wire breakage
"ALM" blinks 8 times repeatedly	Parameter error
"ALM" blinks 9 times repeatedly	Command speed error
"ALM" blinks 10 times repeatedly	Limit reached

- When an alarm occurs, the "ALM" LED blinks and the winding current of the stepping motor is cut off and the status will shift to a "non-excitation" state. At the same time, an output signal is transmitted from the alarm output terminal of the I/O signal connector to the outside.
- In the event of an alarm, identify the cause of the alarm from the number of LED blinks, eliminate the cause, and turn on the power supply again.
- In the case of an alarm, the LED will be lit for about 1 second followed by blinks; in the case of a warning, the LED will only blink.

Connections and Signals

External wiring diagram

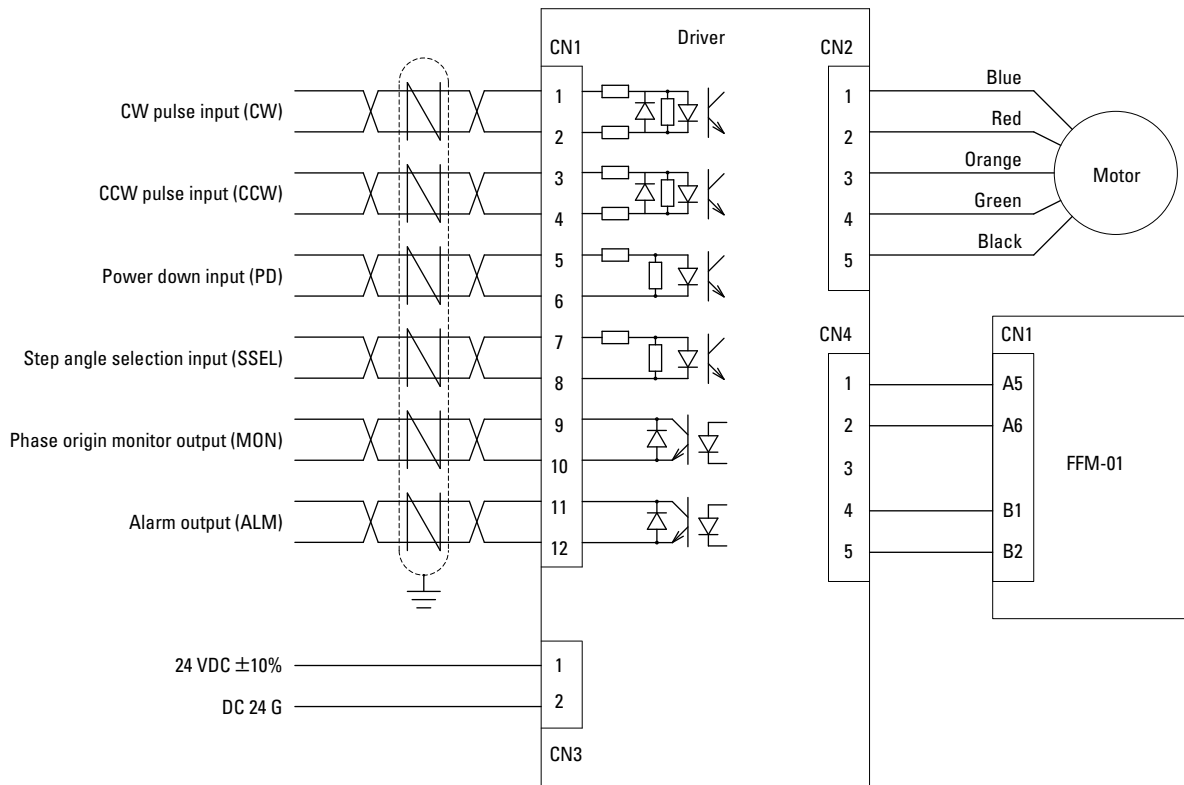

Cable size

Part	Applicable wire	Insulation diameter	Wire length
Power cable	20 AWG (0.5 mm ²) to 18 AWG (0.75 mm ²)	ø1.7 to ø3.0 mm	Below 3 m
I/O signal cable	24 AWG (0.2 mm ²) to 22 AWG (0.3 mm ²)	ø1.0 to ø1.5 mm	Below 2 m
Motor cable	20 AWG (0.5 mm ²) to 18 AWG (0.75 mm ²)	ø1.7 to ø3.0 mm	Below 10 m

Note: When bundling wire together or running wires through the duct, take the reduction rate of each wire allowable current into consideration.
 When the ambient temperature is relatively high, the wire service life will be shortened due to thermal deterioration.
 In this case, please use Heat-resistant Indoor PVC (HIV).

Input/output signal specification overview

Signal	CN1 Pin no.	Function overview
CW pulse input	1 2	When in 2-input mode, a CW-direction pulse is input.
Pulse train input	1 2	When in 1-input mode, a drive pulse train is input to rotate the motor.
CCW pulse input	3 4	When in 2-input mode, a CCW-direction pulse is input.
Rotational direction input	3 4	When in 1-input mode, a drive pulse is input to designate the rotational direction. Internal photocoupler ON ... CW direction Internal photocoupler OFF ... CCW direction
Power down input (Standard)	5 6	Shuts down the motor current. The terminal function can be selected in the setup software as a GPIO 1 signal.
Step angle selection input (Standard)	7 8	Enables the number of step divisions set with the setup software. The terminal function can be selected in the setup software as a GPIO 2 signal.
Phase origin monitor output (Standard)	9 10	Turned on when the excitation phase is at the origin. Output logic is the normally-open contact. The terminal function can be selected in the setup software as a GPIO 1 signal.
Alarm output (Standard)	11 12	Turned on when an alarm occurs. The motor shifts to a "non-excitation" state. Output logic is the normally-open contact. The terminal function can be selected in the setup software as a GPIO 2 signal.

Note: The CW direction refers to the clockwise direction when the motor is viewed from the output shaft side.
 The CCW direction refers to the counter-clockwise direction when the motor is viewed from the output shaft side.

CW (CK) and CCW (U/D) Input Circuit Configuration

Connection example

Pulse crest value

High-level: 4.0 to 5.25 V, low-level: 0 to 0.5 V, high-to-low: 4.0 V or more

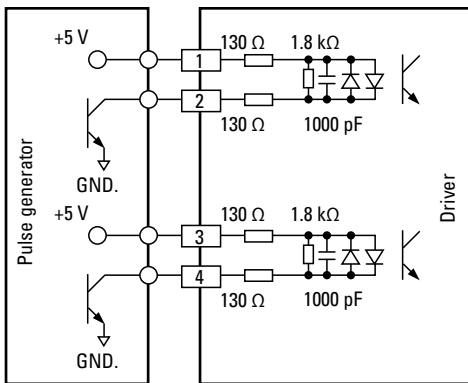

- Ensure that the pulse duty is 50% or less.
- Maximum input frequency is 400 kpulse/s.
- If the peak voltage of the input signal exceeds 5.25 V, add an external current-limiting resistor R to limit the input current to around 10 mA. (Take the photocoupler forward voltage of 1.5 V into consideration.)

Input signal specifications

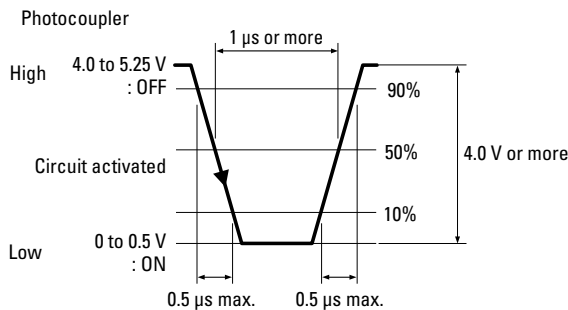

Command pulse timing

2-input mode

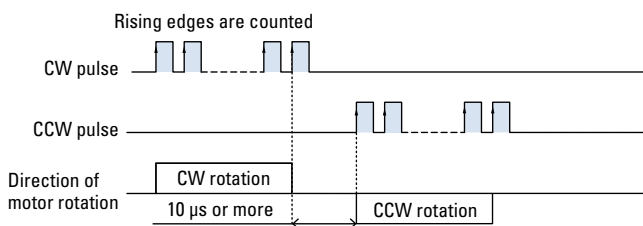

- Shaded areas indicate that internal photocoupler is ON. Internal circuit (motor) starts operating at the rising edge of the photocoupler ON.
- When applying a pulse to CW, set the CCW-side internal photocoupler to OFF.
- When applying a pulse to CCW, set the CW-side internal photocoupler to OFF.
- The CW/CCW pulse switching time of "10 μs or more" is the operating time for the driver internal circuit, not the motor response time. Set a time in which the motor can respond for actual operations.
- 1- and 2-input modes can be switched by DIP switch (F/R) settings.

1-input mode

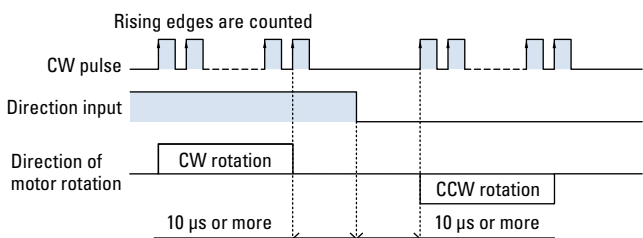

- Shaded areas indicate that internal photocoupler is ON. Internal circuit (motor) starts operating at the rising edge of the photocoupler ON.
- When applying a pulse to CW, set the CCW-side internal photocoupler to OFF.
- When applying a pulse to CCW, set the CW-side internal photocoupler to OFF.
- The CW/CCW pulse switching time of "10 μs or more" is the operating time for the driver internal circuit, not the motor response time. Set a time in which the motor can respond for actual operations.
- 1- and 2-input modes can be switched by DIP switch (F/R) settings.

SSEL and PD Input Circuit Configuration

Connection example

Pulse crest value

High-level: 4.0 to 5.25 V, Low-level: 0 to 0.5 V

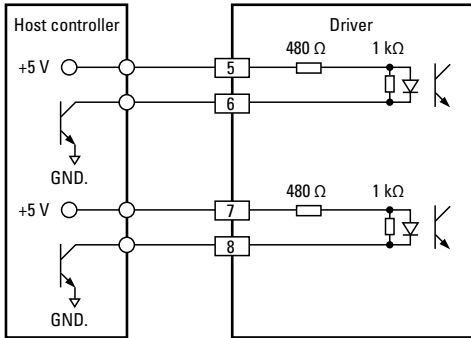

- If the peak voltage of the input signal exceeds 5.25 V, add an external current-limiting resistor R to limit the input current to around 6 mA. (Take the photocoupler forward voltage of 1.5 V into consideration.)

MON and ALM Output Circuit Configuration

Connection example

Collector-to-emitter voltage	30 VDC or less
Output current	10 mA or less
Output saturation voltage	1.0 V or less

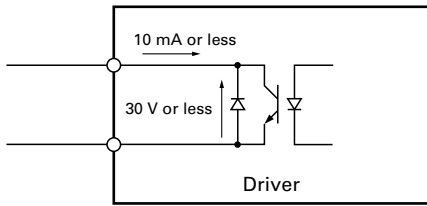

MON output

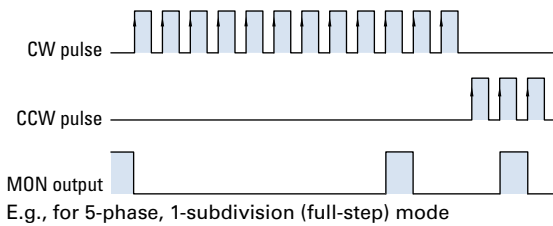

- Photocoppler is turned on when the motor's excitation phase is at the origin.
- Inputting pulse turns on photocoupler every 7.2° of motor output axis from the phase origin.
- Set command frequency to 30 kpulse/s or less when using the phase origin monitor.
- Perform switching of subdivisions via step angle selection input (SSEL) with phase origin monitor output turned on and motor being stopped.
- If the number of divisions is switched at a point other than the excitation origin, the phase origin monitor output may not be output correctly.

DC Input Drivers/Motors

Basic Models

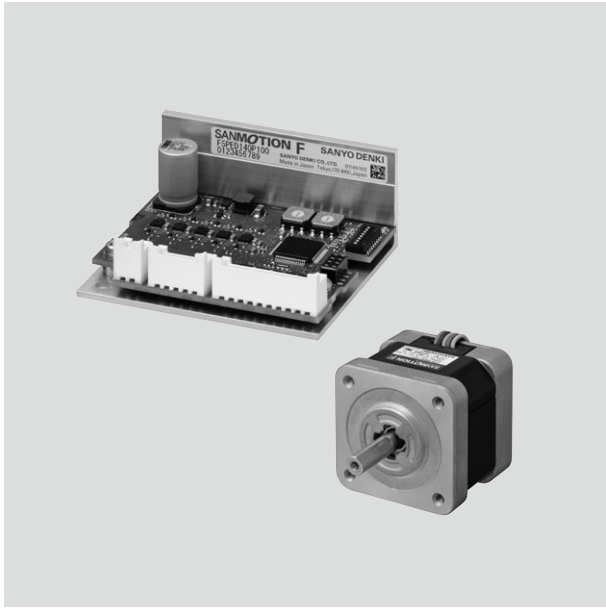

The small, lightweight basic models are compatible with the current models for easy replacement.

Lineup RoHS

Driver CE UK CA TUV c UL US

Model: F5PED140P100
Input voltage: 24 VDC

- The Instruction Manual is available for download from our website.

Motor New pentagon configuration

Motor size: 28 mm sq., 42 mm sq., 60 mm sq., 86 mm sq.

Options

Cable with connectors

System Configuration

- ① Power supply cable (option)
- ② Motor cable (option)
- ③ I/O signal cable (option)

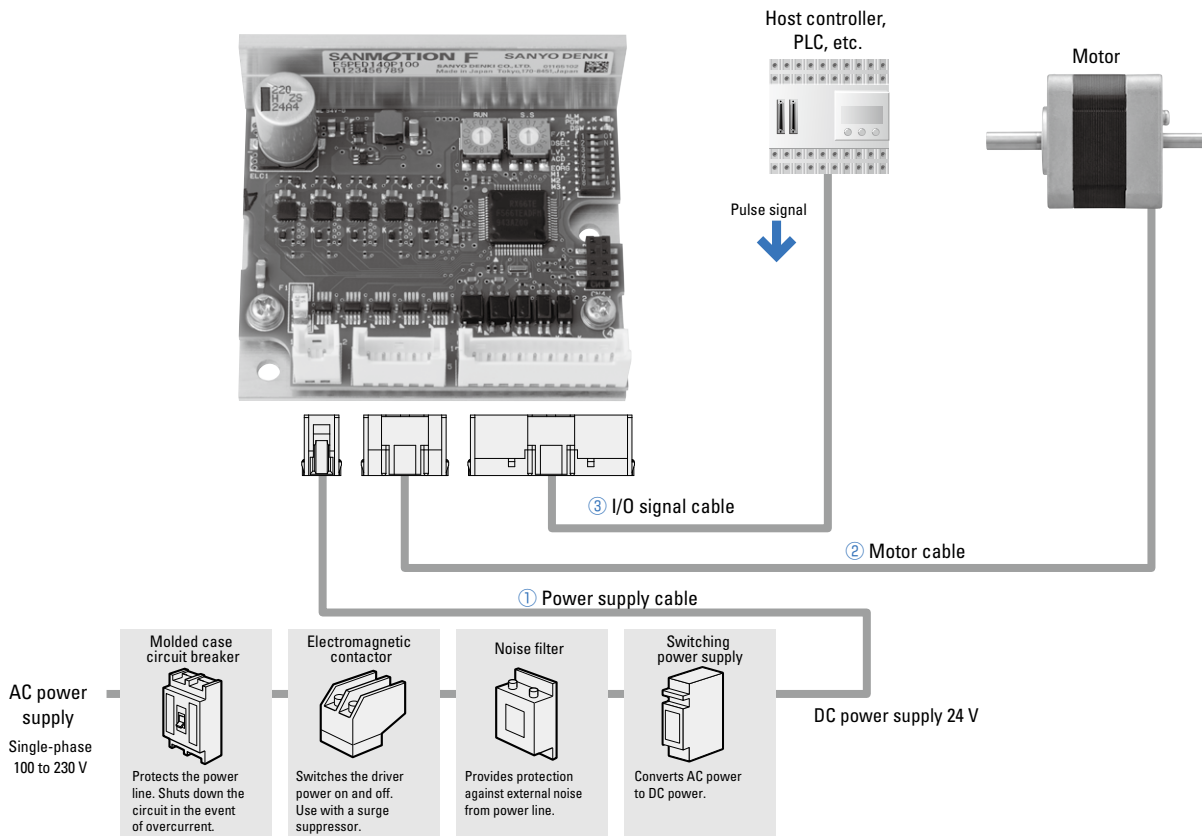

Combination Table

Full step angle: 0.72°

Model	Motor				Driver		Options				
	Motor size	Single shaft	Dual shaft	Page		Model no.	Page	Power supply cable	Motor cable	I/O signal cable	
				Specifications	Dimensions						
Standard models	28 mm sq.	SH5281-7241	SH5281-7211	p. 62, 65	p. 64	F5PED140P100	p. 66	FC8P0010A	FC8M0010B	FC8S0010A	
		SH5285-7241	SH5285-7211	p. 62, 65	p. 64						
	42 mm sq.	SF5421-8241	SF5421-8211	p. 62, 65	p. 64	F5PED140P100	p. 66	FC8P0010A	FC8M0010B	FC8S0010A	
		SF5422-8241	SF5422-8211	p. 62, 65	p. 64						
	60 mm sq.	SM5601-8241	SM5601-8211	p. 63, 65	p. 64	F5PED140P100	p. 66	FC8P0010A	FC8M0010B	FC8S0010A	
		SM5602-8241	SM5602-8211	p. 63, 65	p. 64						
	86 mm sq.	SM5603-8241	SM5603-8211	p. 63, 65	p. 64	F5PED140P100	p. 66	FC8P0010A	FC8M0010B	FC8S0010A	
		SM5861-8241	SM5861-8211	p. 63, 65	p. 64						
			SM5862-8241	SM5862-8211	p. 63, 65	p. 64					

Note 1: Motors listed above are the lead type.

Note 2: Contact us for models with a gear, encoder, or brake.

Options

● **Cables with connectors** DC input motors are the lead type without connectors. Motor-side connectors and connection units need to be prepared by customers.

Power supply cable (Model no.: FC8P0010A)

Pin no.	Color
1	White
2	Black

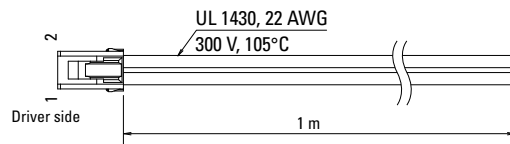

Motor cable (Model no.: FC8M0010B)

Pin no.	Color
1	Blue
2	Red
3	Orange
4	Green
5	Black

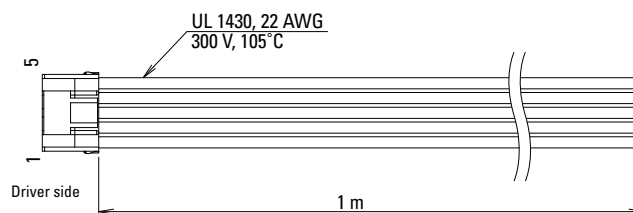

I/O signal cable (Model no.: FC8S0010A)

Pin no.	Color
1	Blue
2	
3	
4	
5	
6	
7	
8	
9	
10	

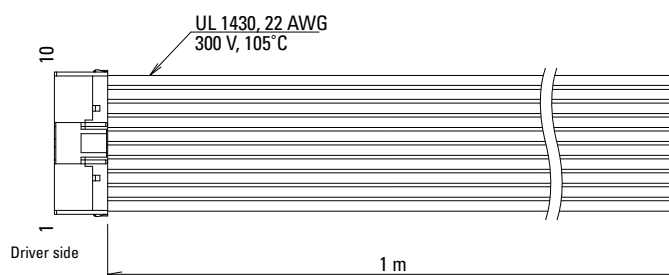

Standard models DC input driver (Model no.: F5PED140P100) + Standard motor

RoHS

Full step angle: 0.72°

Motor size		28 mm sq.		42 mm sq.		
Motor length		32 mm	51.5 mm	35 mm	41 mm	49 mm
Single shaft	Motor model no.	SH5281-7241	SH5285-7241	SF5421-8241	SF5422-8241	SF5423-8241
Dual shaft	Motor model no.	SH5281-7211	SH5285-7211	SF5421-8211	SF5422-8211	SF5423-8211
Holding torque	N·m or more	0.041	0.078	0.125	0.185	0.245
Rotor inertia	×10 ⁻⁴ ·kg·m ²	0.01	0.022	0.028	0.045	0.056
Rated current	A/phase	0.75	0.75	1.4	1.4	1.4
Motor mass ⁽¹⁾	kg	0.11	0.2	0.24	0.31	0.38
Allowable thrust load	N	3	3	10	10	10
Allowable radial load ⁽²⁾	N	42	49	56	54	52

Note: The 28 mm sq. size motor cannot be connected directly to the driver due to its power line being too thin. Please relay the connection using a 20 to 26 AWG wire.

(1) Driver mass ▶ p. 66

(2) Load is exerted to the shaft end.

Characteristics

With rubber coupling used Pull-out torque — Input current (with no load) - - - - Input current (with load) ····· fs: Maximum starting frequency with no load ●

SH5281-7241 SH5281-7211

24 VDC

Winding current: 0.75 A/phase

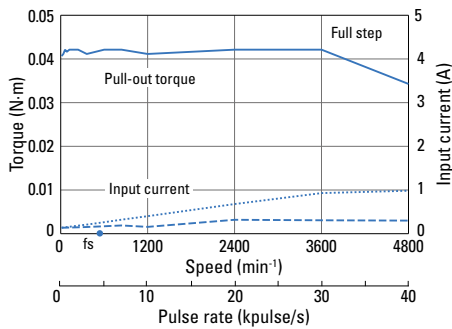

SH5285-7241 SH5285-7211

24 VDC

Winding current: 0.75 A/phase

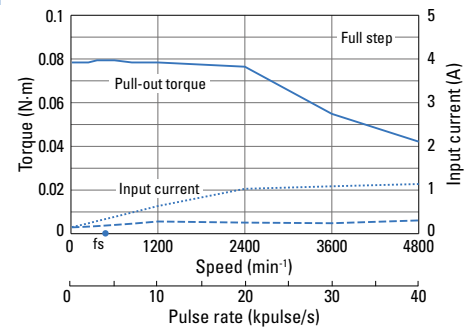

SF5421-8241 SF5421-8211

24 VDC

Winding current: 1.4 A/phase

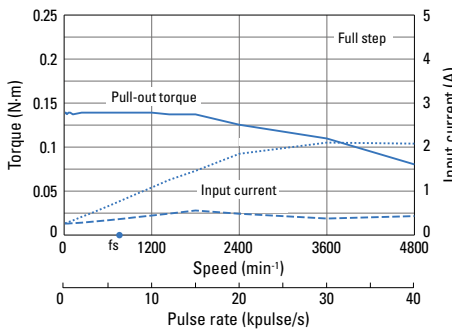

SF5422-8241 SF5422-8211

24 VDC

Winding current: 1.4 A/phase

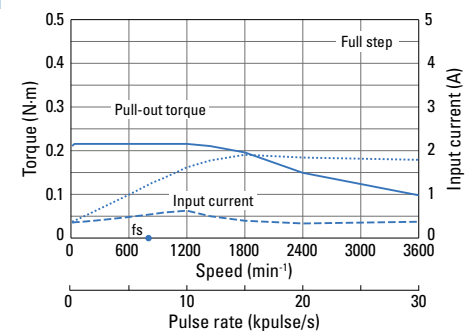

SF5423-8241 SF5423-8211

24 VDC

Winding current: 1.4 A/phase

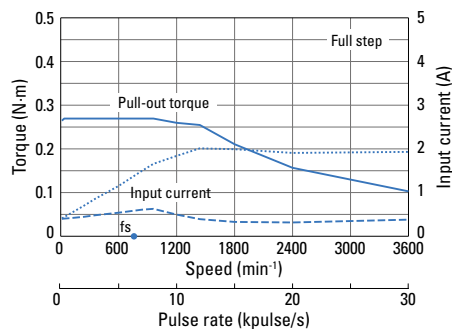

Full step angle: 0.72°

Motor size		60 mm sq.			86 mm sq.	
Motor length		49 mm	60 mm	89 mm	66 mm	96.5 mm
Single shaft	Motor model no.	SM5601-8241	SM5602-8241	SM5603-8241	SM5861-8241	SM5862-8241
Dual shaft	Motor model no.	SM5601-8211	SM5602-8211	SM5603-8211	SM5861-8211	SM5862-8211
Holding torque	N·m or more	0.57	0.9	1.7	2.3	4.4
Rotor inertia	$\times 10^{-4}$ kg·m ²	0.2	0.31	0.6	1.48	3
Rated current	A/phase	1.4	1.4	1.4	1.4	1.4
Motor mass ⁽¹⁾	kg	0.62	0.8	1.27	1.75	2.9
Allowable thrust load	N	20	20	20	60	60
Allowable radial load ⁽²⁾	N	191	183	170	200	200

(1) For the driver mass, see ▶ p. 66
 (2) Load is exerted to the shaft end.

Characteristics

Winding current: 1.4 A/phase Pull-out torque — Input current (with no load) - - - - Input current (with load) ····· fs: Maximum starting frequency with no load ●
 With rubber coupling used

SM5601-8241
SM5601-8211

24 VDC

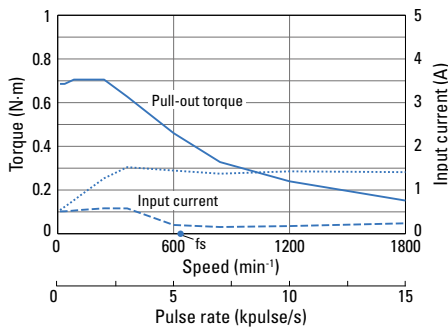

SM5602-8241
SM5602-8211

24 VDC

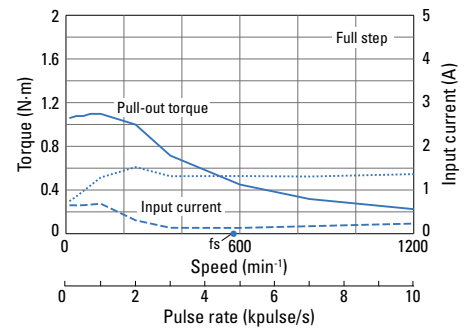

SM5603-8241
SM5603-8211

24 VDC

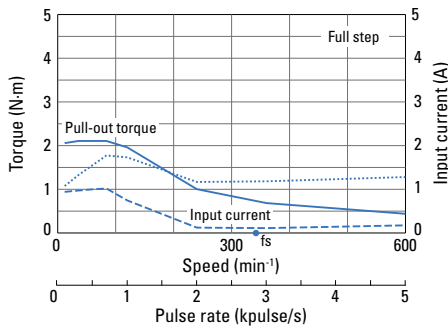

SM5861-8241
SM5861-8211

24 VDC

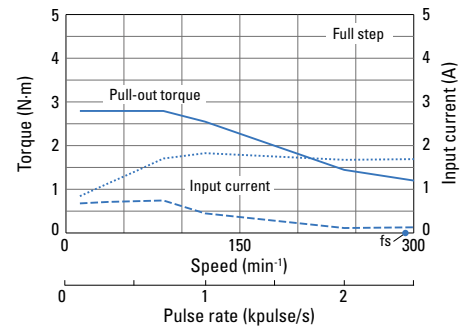

SM5862-8241
SM5862-8211

24 VDC

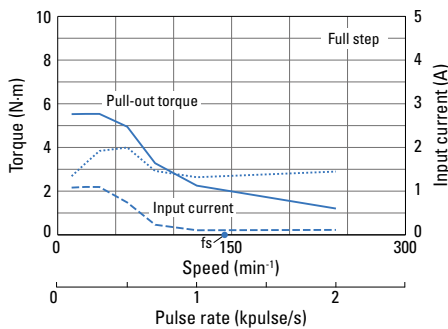

Stepping Motor Dimensions Unit: mm

Standard models

28 mm sq.

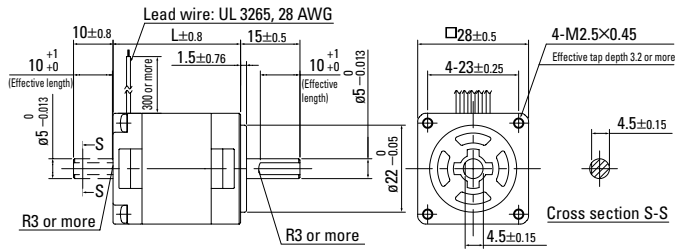

Motor model no.		Motor length (L)
Single shaft	Dual shaft	
SH5281-7241	SH5281-7211	32
SH5285-7241	SH5285-7211	51.5

42 mm sq.

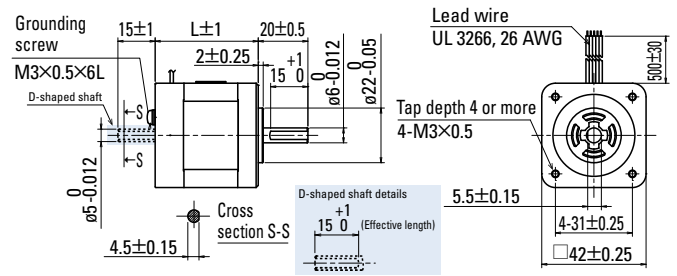

Motor model no.		Motor length (L)
Single shaft	Dual shaft	
SF5421-8241	SF5421-8211	35
SF5422-8241	SF5422-8211	41
SF5423-8241	SF5423-8211	49

60 mm sq.

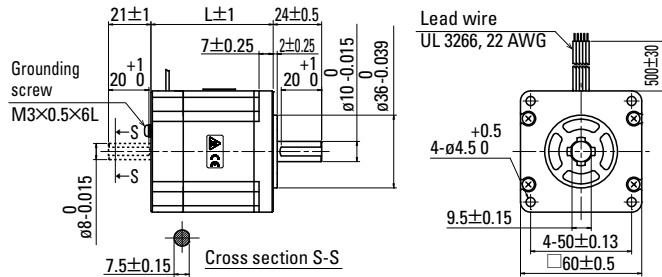

Motor model no.		Motor length (L)
Single shaft	Dual shaft	
SM5601-8241	SM5601-8211	49
SM5602-8241	SM5602-8211	60
SM5603-8241	SM5603-8211	89

86 mm sq.

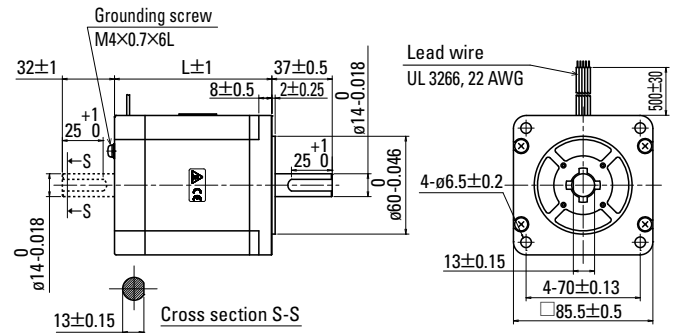

Motor model no.		Motor length (L)
Single shaft	Dual shaft	
SM5861-8241	SM5861-8211	66
SM5862-8241	SM5862-8211	96.5

General Specifications of Stepping Motors

Motor model no.	SH528□	SF542□	SM560□	SM586□
Operation type	—		Continuous operation (S1)	
Operating ambient temperature	-10 to +50°C (0 to +40°C for harmonic gear models)		-10 to +40°C (0 to +40°C for harmonic gear models)	
Storage temperature	-20 to +65°C		-20 to +60°C	
Operating ambient humidity	20 to 90% RH (non-condensing)		95% RH or less: Below 40°C (non-condensing)	
Storage humidity	5 to 95% RH (non-condensing)		95% RH or less: Below 40°C, 57% RH or less: Below 50°C, 35% RH or less: Below 60°C (non-condensing)	
Operating altitude	Up to 1000 m above sea level			
Vibration resistance	Frequency 10 to 500 Hz, amplitude 1.52 mm (10 to 70 Hz), vibration acceleration 150 m/s ² (70 to 500 Hz), sweep time 15 min/cycle, a total of 12 tests in both opposite directions for each of X, Y, and Z axes.			
Shock resistance	Acceleration 500 m/s ² , duration 11 ms, half sine wave, tested 3 times in both directions for each X, Y, and Z axis for a total of 18 times			
Thermal class	B (+130°C)		F (+155°C)	
Dielectric strength	500 VAC for 1 minute (between motor winding and frame)		1500 VAC for 1 minute (between motor winding and frame)	
Insulation resistance	100 MΩ min. at 500 VDC (between motor winding and frame)			
Protection rating	IP40			
Winding temperature rise	80 K or less (based on our own standard)		85 K or less (based on our own standard)	
Positional accuracy tolerance	±0.09°			
Thrust play ⁽¹⁾	0.075 mm or less (With a 1.5 N load)	0.075 mm or less (With a 5 N load)	0.075 mm or less (With a 10 N load)	0.075 mm or less (With a 10 N load)
Radial play ⁽²⁾	0.025 mm or less (With a 5 N load)	0.025 mm or less (With a 5 N load)	0.025 mm or less (With a 5 N load)	0.025 mm or less (With a 5 N load)
Shaft runout	0.025 mm	0.025 mm	0.025 mm	0.025 mm
Concentricity of motor shaft and fitting part	ø0.05 mm	ø0.05 mm	ø0.075 mm	ø0.075 mm
Perpendicularity of mounting surface and motor shaft	0.1 mm	0.1 mm	0.1 mm	0.15 mm
Motor mounting orientation	Can be installed vertically or horizontally.			

(1) Thrust play: Maximum shaft position displacement when a load is exerted in a direction parallel to the motor shaft.

(2) Radial play: Maximum shaft position displacement when a load is exerted in a direction perpendicular to the motor shaft.
Load is exerted on the point 1/3 the shaft length from the shaft end.

Safety standards

Model no.: SM560□, SM586□

CE marking for EU Directive	Directive	Standards	
	Low Voltage Directive 2014/35/EU	IEC 60034-1, IEC 60034-5	
RoHS Directive 2011/65/EU	EN IEC 63000: 2018		
UKCA marking for Great Britain (UK Conformity Assessed Marking)	Electrical Equipment (Safety) Regulations 2016	IEC 60034-1, IEC 60034-5	
	RoHS Regulations 2012	EN IEC 63000: 2018	
UL	Classification	Standards	File no.
	UL	UL 1004-1, UL 1004-6	E179832 (PRHZ2)
	cUL	CSA C22.2 No.100	E179832 (PRHZ8)

Internal Wiring and Rotational Directions

Internal wiring

Wiring: New pentagon configuration

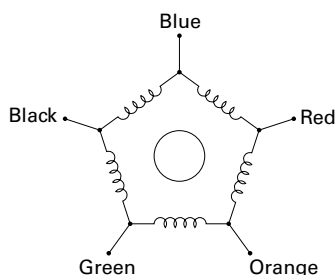

Direction of motor rotation

When excited by a direct current in the order shown below, the direction of rotation is clockwise as viewed from the output shaft side.

Note: This is in the case of standard models and EM brake models.

Contact us for geared models as some of them have different direction of motor rotation.

Lead color	Excitation sequence	1	2	3	4	5	6	7	8	9	10
		Blue			+	+	+			-	-
Red		-	-			+	+	+		-	
Orange			-	-	-			+	+	+	
Green		+			-	-	-			+	
Black		+	+	+			-	-	-	+	

Driver Dimensions Unit: mm

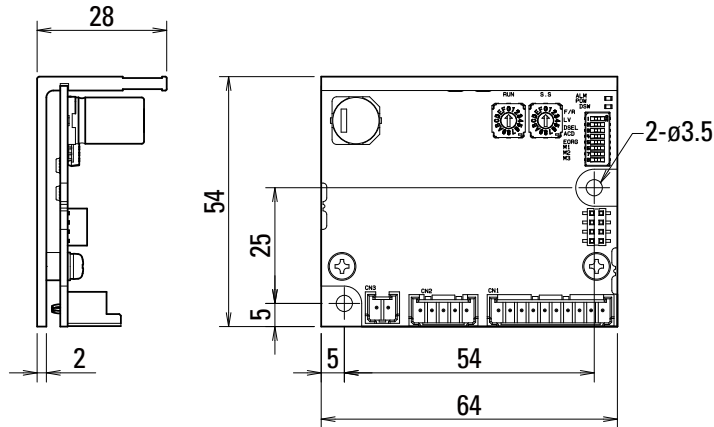

Driver Specifications

General specifications

Model no.		F5PED140P100	
Basic specifications	Input voltage	24 VDC \pm 10%	
	Input current	3 A	
	Environment	Protection class	Class III
		Operating environment	Installation category (Overvoltage category): I (CE), pollution level: 2
		Operating ambient temperature	0 to +50°C
		Storage temperature	-20 to +70°C
		Operating ambient humidity	90% RH or less (non-condensing)
		Storage humidity	90% RH or less (non-condensing)
		Operating altitude	Up to 1000 m above sea level
		Vibration resistance	5 m/s ² freq. range 10 to 55 Hz tested for 2 hours in each X, Y and Z-axis directions.
		Shock resistance	20m/s ²
		Dielectric strength	700 VDC for 1 minute (between power input terminal and chassis)
	Insulation resistance	10 MΩ min. at 500 VDC (between power input terminal and chassis)	
Mass	0.06 kg		
Functions	Mode selection	Pulse input mode (1-/2-input mode), low-vibration mode (on/off), automatic current limiting (on/off), step division mode (2-/5-phase mode), initial excitation phase (excitation origin/excitation phase of last power off), motor selection, operating current, step angle	
	Protection functions	Power supply voltage monitoring, overheat detection, overcurrent protection, non-volatile memory checksum error, hardware error, motor wire breakage detection, command speed error	
	LED indicators	Power supply, alarm/warning indicator	
	PC-based functions	—	
I/O signal	Command pulse input signal	Photocoupler input method; input resistance: 260 Ω High-level input signal voltage: 4.0 to 5.25 V, Low-level input signal voltage: 0 to 0.5 V high-to-low voltage: 4.0 V or more Maximum input frequency 400 kpulse/s	
	Power down input signal	Photocoupler input method; input resistance: 480 Ω High-level input signal voltage: 4.0 to 5.25 V, Low-level input signal voltage: 0 to 0.5 V	
	Step angle selection input signal	—	
	Phase origin monitor output	Open-collector output through photocoupler, collector-to-emitter voltage: 30 VDC or less Output current: 10 mA or less, Output saturation voltage: 1.0 V or less	

Safety standards

Safety standards		Standards
Directive	Directive	
UL/cUL standards	—	UL 61800-5-1 (File no. E179775)
KC mark (Korea Certification Mark)	—	KS C 9610-6-2, KS C 9610-6-4
CE marking for EU Directive	Low Voltage Directive 2014/35/EU	EN 61800-5-1
	Electromagnetic Compatibility Directive (2014/30/EU)	EN 61000-6-2 EN 61000-6-4
	RoHS Directive 2011/65/EU	EN IEC 63000: 2018
UKCA marking for Great Britain (UK Conformity Assessed Marking)	Electrical Equipment (Safety) Regulations 2016	EN 61800-5-1
	Electromagnetic Compatibility Regulations 2016	EN 61000-6-2 EN 61000-6-4
	RoHS Regulations 2012	EN IEC 63000: 2018

Driver Part Names and Functions

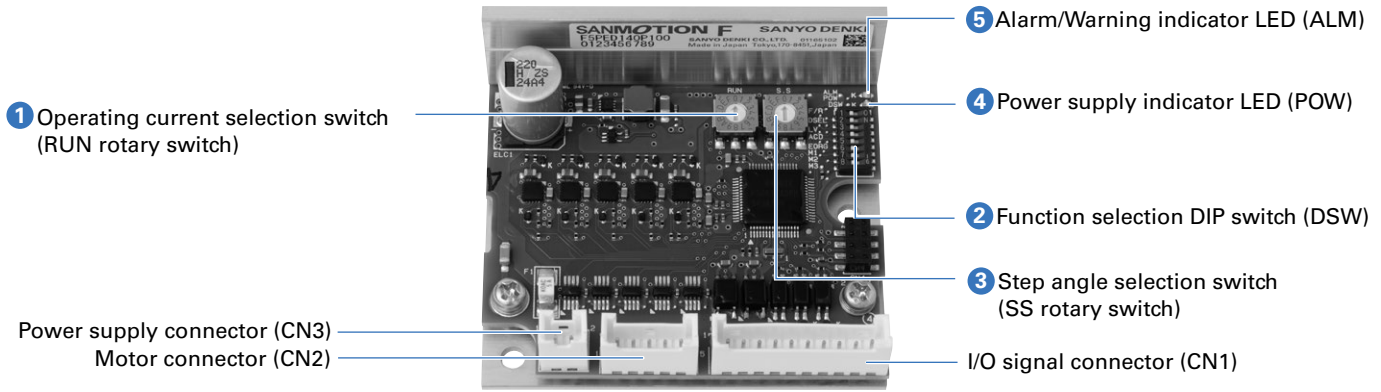

1. Operating current selection switch (RUN rotary switch)

The value of the motor operating current can be set with a rotary switch.

Dial	0	1	2	3	4	5	6	7
Motor current (A)	1.4	1.33	1.26	1.19	1.12	1.05	0.98	0.91
Dial	8	9	A	B	C	D	E	F
Motor current (A)	0.84	0.77	0.7	0.63	0.56	0.49	0.42	0.35

The factory setting is F (0.35 A). Select the operating current after checking the rated current of the combination motor.

2. Function selection DIP switch (DSW)

Functions can be selected to suit your application.

Factory settings

F/R	<input type="checkbox"/> OFF	Pulse input mode selection
LV	<input type="checkbox"/> ON	Low-vibration mode
DSEL	<input type="checkbox"/> OFF	Step division mode
ACD	<input type="checkbox"/> ON	Auto-Current-Down
EORG	<input type="checkbox"/> OFF	Excitation selection
M1	<input type="checkbox"/> OFF	Motor selection
M2	<input type="checkbox"/> OFF	
M3	<input type="checkbox"/> OFF	
M3	<input type="checkbox"/> OFF	

- First, do the settings of the motor to be combined with the driver.
- Make sure to turn off the power supply of the driver when changing the settings of the function selection DIP switch.

Combination motor settings

M1	M2	M3	Wiring current: 0.75 A/phase ⁽¹⁾	Wiring current: 1.4 A/phase
			Motor size	Model no.
OFF	OFF	OFF	28 mm sq.	SH5281-72□1 SH5285-72□1
ON	OFF	OFF	Reserved	42 mm sq. SF5422-82□1
OFF	ON	OFF	Reserved	42 mm sq. SF5423-82□1
ON	ON	OFF	Reserved	60 mm sq. SM5601-82□1
OFF	OFF	ON	Reserved	60 mm sq. SM5602-82□1
ON	OFF	ON	Reserved	60 mm sq. SM5603-82□1
OFF	ON	ON	Reserved	86 mm sq. SM5861-82□1
ON	ON	ON	Reserved	86 mm sq. SM5862-82□1
ON	ON	ON	Reserved	Reserved

(1)When using a 0.75 A/phase motor, be sure to set the operating current selection switch (RUN rotary switch) to 50% or less. Failure to follow this may cause the motor to overheat and burnout.

1. Pulse input mode selection (F/R)

Pulse input mode can be selected.

F/R	Pulse input mode
ON	1-input mode (CK, U/D)
OFF	2-input mode (CW, CCW)

2. Low-vibration mode selection (LV)

Motors can smoothly operate even at low-resolution settings such as full-step (1 subdivision) and half-step (2 subdivisions) modes.

LV	Operation mode
ON	Low-vibration mode enabled
OFF	Low-vibration mode disabled

3. Step division mode selection (DSEL)

Select the step angle selection switch (SS rotary switch) mode.

DSEL	Resolution mode
ON	2-phase mode: Operable as a normal 2-phase stepping system with a step angle of 1.8° to 0.00703125°.
OFF	5-phase mode: Operable as a normal 5-phase stepping system with a step angle of 0.72° to 0.00288°.

4. Auto-Current-Down (ACD)

This function reduces the motor current at rest (200 ms after the last pulse is applied), which is effective in suppressing heat generation and reducing the current consumption of the motor and driver.

ACD	Current at rest
ON	50% of driving current
OFF	100% of driving current

5. Excitation selection (EORG)

The excitation phase at the time of power-on is selected.

EORG	The excitation phase at power-on
ON	The excitation phase at power-off
OFF	Excitation origin

By turning on EORG, the excitation phase at the time of power-f will be saved.

Therefore, there will be no shaft displacement when the power is turned on next time.

3. Step angle selection switch (SS rotary switch)

The number of subdivisions for a full step can be set with the rotary switch.

After selecting 2- or 5-phase mode by setting the "3" (DSEL) of the DSW (function selection DIP switch), set the step angle selection switch for the desired step angle.

5-phase mode: When the DSW's "3" (DSEL) is set to OFF				2-phase mode: When the DSW's "3" (DSEL) is set to ON			
SS	Microsteps	Resolution	Step angle	SS	Microsteps	Resolution	Step angle
0	1	500	0.72°	0	0.4	200	1.8°
1	2	1000	0.36°	1	0.8	400	0.9°
2	2.5	1250	0.288°	2	1.6	800	0.45°
3	4	2000	0.18°	3	2	1000	0.36°
4	5	2500	0.144°	4	3.2	1600	0.225°
5	8	4000	0.09°	5	4	2000	0.18°
6	10	5000	0.072°	6	6.4	3200	0.1125°
7	20	10000	0.036°	7	10	5000	0.072°
8	25	12500	0.0288°	8	12.8	6400	0.05625°
9	40	20000	0.018°	9	20	10000	0.036°
A	50	25000	0.0144°	A	25.6	12800	0.028125°
B	80	40000	0.009°	B	40	20000	0.018°
C	100	50000	0.0072°	C	50	25000	0.0144°
D	125	62500	0.00576°	D	51.2	25600	0.0140625°
E	200	100000	0.0036°	E	100	50000	0.0072°
F	250	125000	0.00288°	F	102.4	51200	0.00703125°

- The factory setting is "1".

4. Power supply monitoring LED (POW)

Lights up when the control and main circuit power supply are turned on.

5. Alarm/Warning indicator LED (ALM)

Flashes repeatedly when an alarm is generated.

LED indicators	Status
"ALM" blinks once repeatedly	Main power supply undervoltage
"ALM" blinks 2 times repeatedly	Main power supply overvoltage
"ALM" blinks 3 times repeatedly	Driver overheat
"ALM" blinks 4 times repeatedly	Overcurrent
"ALM" blinks 5 times repeatedly	Non-volatile memory checksum error
"ALM" blinks 6 times repeatedly	Hardware error
"ALM" blinks 7 times repeatedly	Motor wire breakage
"ALM" blinks 9 times repeatedly	Command speed error

- When an alarm occurs, the "ALM" LED blinks and the winding current of the stepping motor is cut off and the status will shift to a "non-excitation" state. At the same time, an output signal is transmitted from the alarm output terminal of the I/O signal connector to the outside.
- In the event of an alarm, identify the cause of the alarm from the number of LED blinks, eliminate the cause, and turn on the power supply again.
- In the case of an alarm, the LED will be lit for about 1 second followed by blinks; in the case of a warning, the LED will only blink.

Connections and Signals

External wiring diagram

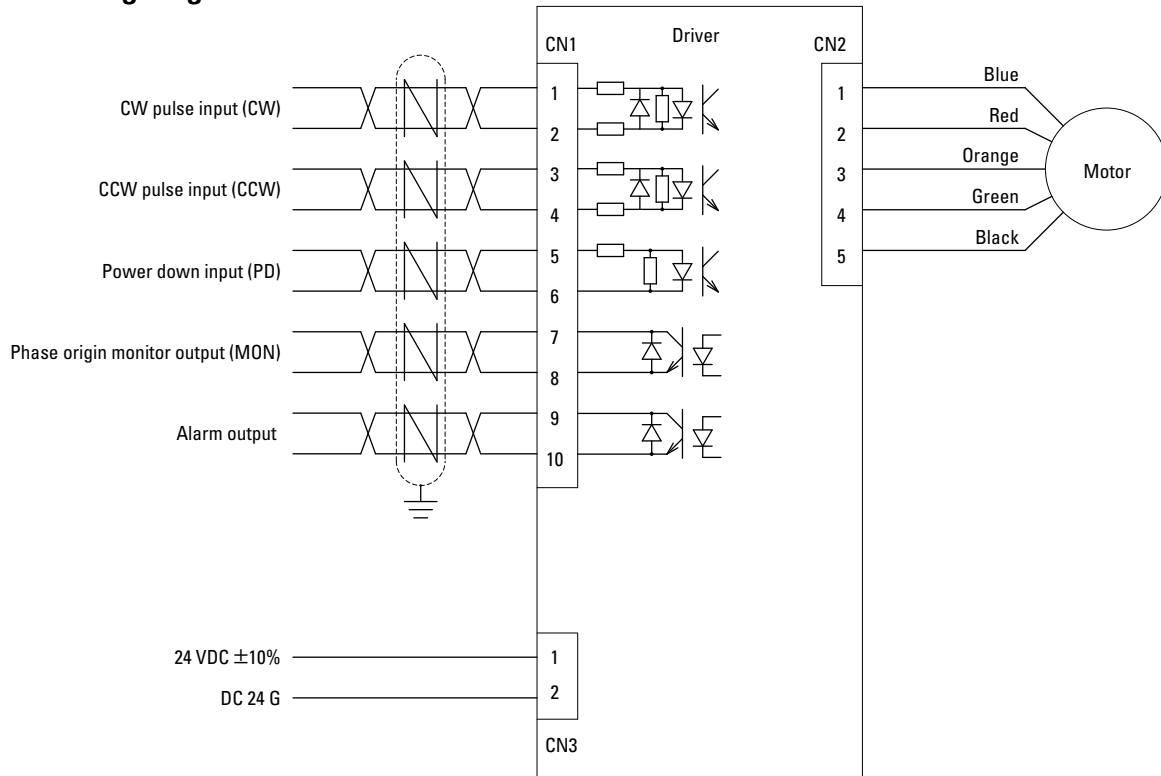

Cable size

Part	Cable size	Insulation diameter	Wire length
Power cable	22 AWG (0.3 mm ²)	ø1.15 to ø1.8 mm	Below 3 m
I/O signal cable	22 AWG (0.3 mm ²)	ø1.15 to ø1.8 mm	Below 2 m
Motor cable	22 AWG (0.3 mm ²)	ø1.15 to ø1.8 mm	Below 10 m

Note: When bundling wire together or running wires through the duct, take the reduction rate of each wire allowable current into consideration.
 When the ambient temperature is relatively high, the wire service life will be shortened due to thermal deterioration.
 In this case, please use Heat-resistant Indoor PVC (HIV).
 When extending the motor wire, use the thickest wire possible.

Input/output signal specification overview

Signal	CN1 pin no.	Function overview
CW pulse input (Standard)	1 2	When in 2-input mode, a CW-direction pulse is input.
Pulse train input	1 2	When in 1-input mode, a drive pulse train is input to rotate the motor.
CCW pulse input (Standard)	3 4	When in 2-input mode, a CCW-direction pulse train is input.
Rotational direction input	3 4	When in 1-input mode, a drive pulse is input to designate the rotational direction. Internal photocoupler ON ... CW direction Internal photocoupler OFF ... CCW direction
Power down input	5 6	A PD signal input will cut off (power off) the current flowing to the motor. Internal photocoupler ON ... PD function is enabled. Internal photocoupler OFF ... PD function is disabled
Phase origin monitor output	7 8	Turned on when the excitation phase is at the origin (when power is turned on). In full step mode, turned on once for 10 pulses. In half step mode, turned on once for 20 pulses.
Alarm output	9 10	When the alarm circuit is activated inside the driver, an alarm signal is output to outside, which turns the stepping motor to non-excited state. The stepping motor shifts to a "non-excitation" state.

Note: The CW direction refers to the clockwise direction when the motor is viewed from the output shaft side.
 The CCW direction refers to the counter-clockwise direction when the motor is viewed from the output shaft side.

CW (CK) and CCW (U/D) Input Circuit Configuration

Connection example

Pulse crest value

High-level: 4.0 to 5.25 V, low-level: 0 to 0.5 V, high-to-low: 4.0 V or more

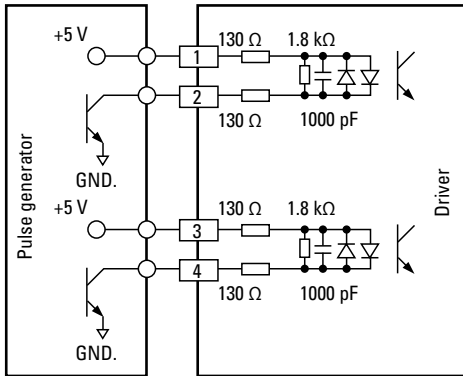

- Ensure that the pulse duty is 50% or less.
- Maximum input frequency is 400 kpulse/s.
- If the peak voltage of the input signal exceeds 5.25 V, add an external current-limiting resistor R to limit the input current to around 10 mA. (Take the photocoupler forward voltage of 1.5 V into consideration.)

Input signal specifications

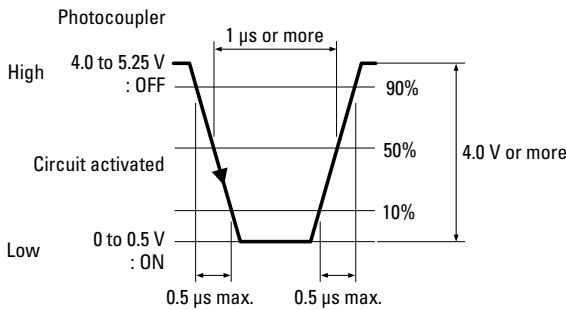

Command pulse timing

2-input mode (CW, CCW)

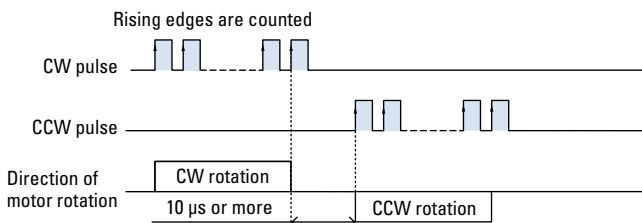

- Shaded areas indicate that the internal photocoupler is ON. Internal circuit (motor) starts operating at the rising edge of the photocoupler ON.
- When applying a pulse to CW, set the CCW-side internal photocoupler to OFF.
- When applying a pulse to CCW, set the CW-side internal photocoupler to OFF.
- The CW/CCW pulse switching time of "10 μs or more" is the operating time for the driver internal circuit, not the motor response time. Set a time in which the motor can respond for actual operations.
- 1- and 2-input modes can be switched by DIP switch (F/R) settings.

1-input mode (CK, U/D)

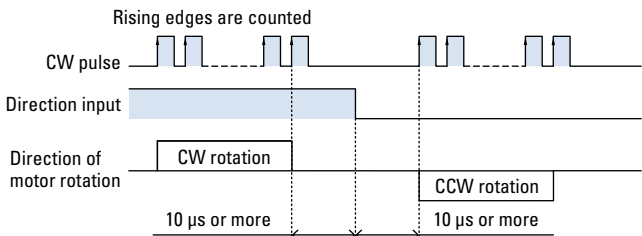

- Shaded areas indicate that the internal photocoupler is ON. Internal circuit (motor) starts operating at the rising edge of the photocoupler ON.
- When applying a pulse to CW, set the CCW-side internal photocoupler to OFF.
- When applying a pulse to CCW, set the CW-side internal photocoupler to OFF.
- The CW/CCW pulse switching time of "10 μs or more" is the operating time for the driver internal circuit, not the motor response time. Set a time in which the motor can respond for actual operations.
- 1- and 2-input modes can be switched by DIP switch (F/R) settings.

PD Input Circuit Configuration

■ Connection example

Pulse crest value

High-level: 4.0 to 5.25 V, Low-level: 0 to 0.5 V

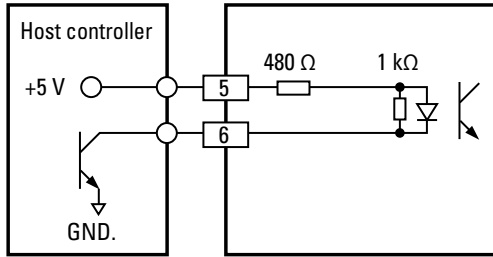

- If the peak voltage of the input signal exceeds 5.25 V, add an external current-limiting resistor R to limit the input current to around 6 mA. (Take the photocopler forward voltage of 1.5 V into consideration.)

MON and ALM Output Circuit Configuration

■ Connection example

Collector-to-emitter voltage	30 VDC or less
Output current	10 mA or less
Output saturation voltage	1.0 V or less

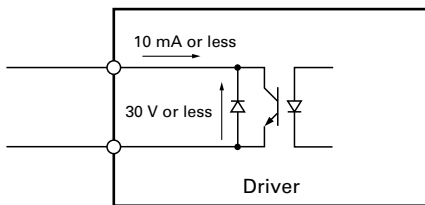

MON output

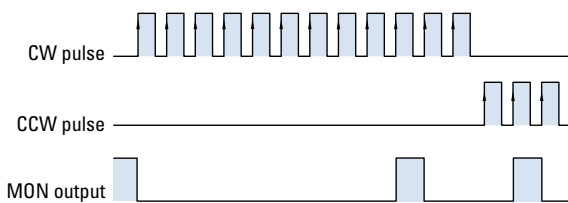

E.g., for 5-phase, 1-subdivision (full-step) mode

- Photocopler is turned on when the motor's excitation phase is at the origin.
- Inputting pulse turns on photocopler every 7.2° of motor output axis from the phase origin.
- Set command frequency to 30 kpulse/s or less when using the phase origin monitor.
- Perform switching of subdivisions via step angle selection input (SSEL) with phase origin monitor output turned on and motor being stopped.
- If the number of divisions is switched at a point other than the excitation origin, the phase origin monitor output may not be output correctly.

Linear Actuator Stepping Motors

In-Vacuum Stepping Motors

Linear Actuator Stepping Motors

▶ p. 72–

In-Vacuum Stepping Motors Custom product

▶ p. 74

Linear Actuator Stepping Motors



Features

- Compact
A stepping motor and ball screw are integrated into one compact unit for downsizing.
- High thrust
- Long stroke

Applications

Semiconductor manufacturing equipment, general industrial machines, machine tools, and conveying machines

Please make sure to prepare a linear guide structure with non-rotating mechanism to support radial load. This is necessary for linear motion.

Specifications

Model no.	SL5421-7241	SL5421-72XB41	SL5601-8241	SL5601-82XB41
Brake	Without	With	Without	With
Motor size	42 mm		60 mm	
Rated current	0.75 A/phase		1.4 A/phase	
Stroke	50 mm		80 mm	
Thrust	370 N		450 N	
Brake output	Without	370 N	Without	450 N
Speed	48 mm/s		64 mm/s	
Resolution	0.004 mm		0.008 mm	
Repetitive positioning accuracy	±0.02 mm			
Lost motion	0.1 mm			
Mass	0.65 kg	0.8 kg	1.4 kg	1.7 kg
Compatible driver model no.	FS1D140P10 ⁽¹⁾			

Wiring: New pentagon configuration

(1) Contact us for details on drivers.

Characteristics

Model no.: SL5421-72□□

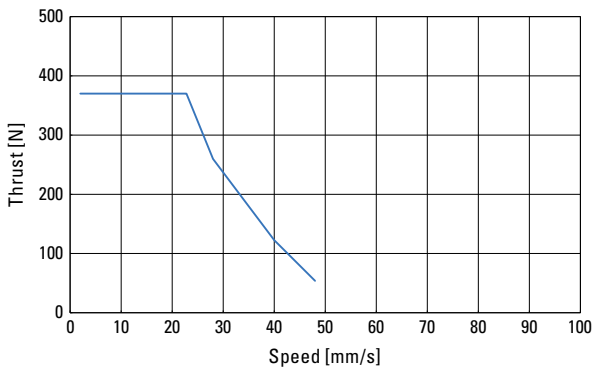

Operating conditions

Driver: FS1D140P10

Input voltage: 24 VDC

Excitation current: 0.75 A/phase

Excitation mode: 4-phase excitation (Full step)

Model no.: SL5601-82□□

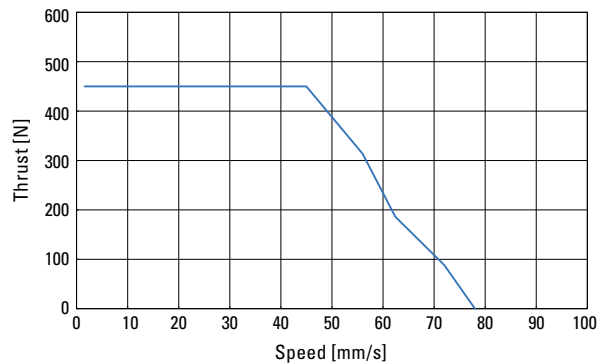

Operating conditions

Driver: FS1D140P10

Input voltage: 24 VDC

Excitation current: 1.4 A/phase

Excitation mode: 4-phase excitation (Full step)

In-Vacuum Motors

Custom product



Features

- These can be driven in vacuum environments without requiring a vacuum feedthrough. These stepping motors can be used as an actuator suitable for vacuum environments while maintaining the feature of a stepping motor—easy high-precision open-loop control.
- We also offer customization for use in a wide range of pressure environments from low vacuum to ultra-high vacuum.
- Baking at 200°C is possible.
- No significant size change from regular stepping motors.

Operable pressure environments

Low vacuum			Medium vacuum			High vacuum			Ultra-high vacuum				
10^5	10^4	10^3	10^2	10^1	1	10^{-1}	10^{-2}	10^{-3}	10^{-4}	10^{-5}	10^{-6}	10^{-7}	10^{-8} [Pa]

Applications

Ideal for the following applications. Contact us to discuss your particular application environment needs.

- Semiconductor manufacturing equipment
- Satellite robots
- Electron microscopes
- Large-scale research facilities such as accelerators, synchrotron radiation analysis equipment, etc.

Motor size

42 to 86 mm sq.

Safety Precautions

The products in this catalog are designed to be used with general industrial equipment. When using them, pay sufficient attention to the following points.

- Read the included Instruction Manual carefully before installing, assembling, and using the product for proper use.
- Do not modify or alter the product in any way.
- Contact us or your point of sale for installation or maintenance services of the product.
- Consult us when using the product for the following uses, as these require special considerations for operations, maintenance, and management such as redundancy and emergency power generators.

- ❶ Use in medical equipment that may have an effect on human life or the human body
- ❷ Use in transportation systems or transport-related equipment such as trains or elevators that may have an effect on human life or the human body
- ❸ Use in computer systems that may have an impact on society or on the public
- ❹ Use in other devices that have a major impact on human safety or on maintaining public operations

- In addition to the above, contact us or your point of sale for use in an environment where vibrations occur, such as in automobiles or transportation.
- For use in space, aviation, or nuclear power-related applications, contact us or your point of sale.
- The products listed in this catalog fall into the category 16 of Appended Table 1 of the Export Trade Control Order. To export these products as an individual part or to export a device into which they are assembled, the "Inform Requirements" and "Objective Requirements"—established by the Ministry of Economy, Trade and Industry of Japan based on the "Catch-all Controls"—must be studied for applicability. Accordingly, appropriate export formalities must be performed.

Safety Precautions

Warning Labels on Products

Either or all of the following symbols are labeled on products depending on the model of driver or stepping motor.



This label is attached in the vicinity of high-voltage portions such as charging or cover-protected parts, to indicate locations with risk of electric shock.



This label is attached in the vicinity of the grounding terminals of drivers to indicate that grounding is required.



This label is attached to the portion of drivers where a voltage of 42.4 VAC or 60 VDC or more is applied, drawing attention to the risk of electric shock.



Indicates that the stepping motor may get hot, resulting in burns.



Indicates that the stepping motor should be grounded.

Safety Alert Symbols

The following safety symbols are used in the manual to indicate different hazardous situations and prohibited/required actions.



DANGER Indicates hazards that could cause severe bodily injury or death as a result of failure to follow the instructions.



CAUTION Indicates possible hazards that could cause moderate bodily injury or only property damage as a result of failure to follow the instructions.

Note that even items with a symbol could potentially lead to serious outcomes, depending on the situation. They all indicate important situations, so be sure to observe them.



PROHIBITED Indicates actions that must not be taken.



COMPULSORY Indicates actions that must be taken.

DANGER

General

- Do not use the product in an explosive, flammable or corrosive atmosphere, watery place or near a combustible material. Failure to follow this may cause injury or fire.
- Only technically qualified personnel should transport, install, wire, operate, or perform maintenance and inspection on the product. Failure to follow this may cause electric shock, injury, or fire.
- Do not work on wiring, maintenance servicing, or inspection with power on. Perform either of those five minutes after turning the power off. Failure to follow this may cause electrical shock.
- When the protective functions of the motor are activated, turn the power off immediately and eliminate the cause. If continuing the operation without eliminating the cause, the product may operate improperly and cause injury or a breakdown of the system devices.
- Stepping motors may step-out when running and stopping depending on the amount of the load. Put the product into use after sufficient trial test operation in the maximum planned load conditions to check that the product can handle the load. Doing otherwise may cause a breakdown of the system. (When used for upward/downward movements, loads may fall due to step-out.)
- Do not touch the internal parts of the driver. Failure to follow this may cause electric shock.

Wiring

- Do not connect the stepping motor directly to a mains outlet. Failure to follow this may cause electric shock, injury, or fire. Stepping motors should be powered by stepping drivers (except for synchronous motors).
- Use an input voltage within the rated voltage range. Using otherwise may cause fire or an electric shock.
- Connect the driver and stepping motor to the ground. Failure to follow this may cause electric shock.
- Do not damage, apply excessive stresses, put heavy things on, or tuck down cables. Failure to follow this may cause electric shock.
- Perform wiring with the power cable as instructed by the wiring diagram or the Instruction Manual. Failure to follow this may cause electric shock or fire.
- Our stepping motor cables are for fixed-wiring use, so do not use products in applications where flex cables are required. Failure to follow this may cause electric shock, injury, or fire.

Operation

- Never touch the rotating part of the stepping motor during its operation. Failure to follow this may cause injury.
- Do not reach or touch the electric terminals while electric power is on. Failure to follow this may cause electric shock.
- Never disconnect any of the connectors while electric power is on. Failure to follow this may cause electric shock or product damage.
- Do not operate products with live parts exposed. Failure to follow this may cause electric shock.
- If smoke, fire, unusual smells, or unusual sounds are produced from the driver or stepping motor, turn off the power and stop using them immediately. Failure to follow this may cause electric shock, injury, or fire.

CAUTION

General

- Prior to installation, operation, maintenance servicing or inspection, be sure to read the Instruction Manual and follow the instructions. Failure to follow this may cause electric shock, injury, or fire.
- Do not use the driver or the stepping motor in conditions that exceed the specification values. Failure to follow this may cause electric shock, injury, or fire.
- Do not insert a finger or an object into the opening of the motor. Failure to follow this may cause electric shock, injury, or fire.
- Do not use a damaged driver or stepping motor. Doing so may cause injury or fire.
- Use the driver and stepping motor in the designated combination. Failure to follow this may cause fire or product failures.
- Be careful when the temperature rises in the operating driver, stepping motor or peripheral devices. Failure to follow this may result in a burn.

- Never disassemble, repair, modify, or alter the motor. Failure to follow this may cause electric shock, injury, or fire.
- Do not remove the nameplate. Using motors with incorrect ratings may result in fire.
- Be careful that this product does not fall or tip over when handling, as this can be dangerous.

Unpacking

- Unpack the box with the right side up. Failure to follow this may cause injury.
- Confirm that the product you received is the one that you have ordered. Installing an incorrect product may cause a damage.

Wiring

- Do not measure the insulation resistance or dielectric strength of the motor by yourself. Failure to follow this may cause product damage. Contact us or your point of sale instead, if such a measurement is required.
- Perform wiring work according to local standards of electrical installations. Failure to follow this may cause motor burnout or fire.
- Perform wiring correctly and securely. Incorrect wiring may cause the stepping motor to run out of control, resulting in injury.
- Insulate the attached condenser and external resistance connection terminals. Failure to follow this may cause electric shock.

Installation

- Do not stand on this product or place heavy objects on top of it. Failure to follow this may cause injury.
- Keep the air intake and exhaust vents free of obstructions and foreign matter. Failure to follow this may cause fire.
- Make sure to use the specified driver mounting direction. Failure to follow this may cause product failures.
- Keep a distance as instructed by the Instruction Manual for the driver from the inner surface of the control console or other devices. Failure to follow this may cause product failures.
- Install the motor with great care to avoid the risk of it falling or tipping over.
- Mount the motor to incombustible materials such as metals. Failure to do so may cause fire, injury, or device breakdown.
- Keep any combustible materials away from where the motor is installed. Failure to do so may result in fire or burns.
- Be sure to secure a ventilation path when installing the motor, and keep the intake and exhaust vents unblocked. Failure to do so may result in electric shock, fire, or device breakdown.
- Check the rotating direction of the motor before connecting it with equipment. Failure to follow this may cause injury or product damage.
- Do not touch the motor output spindle (including the keyway and gears) with your bare hand. Failure to follow this may cause injury.
- Do not apply loads to the motor shaft exceeding the specified allowable load.
- When attaching a pulley or coupling to the output shaft of a stepping motor, make sure that the motor unbalance is small enough. A large motor unbalance will increase vibration, which may result in shortened service life and premature damage.
- Make sure that the axial belt tension does not exceed the allowable load when operating the belt drive. The allowable load can be divided into the thrust (axial) load and radial load applied independently in the individual directions to the output shaft.
- Make sure that the output shaft of the motor and the mating machine are well aligned. Failure to follow this may increase vibration, which may result in shortened service life or premature damage.
- Fix the output shaft of the stepping motor to the mating machine around the entire shaft circumference to prevent fretting.

Operation

- Stepping motors are not equipped with any protective device. Prepare an overvoltage protection device, earth leakage breaker, overheat protection device, and emergency stop device to ensure safe operation. Failure to follow this may cause injury or fire.
- Do not touch the product for a period after the power is on or has been turned off, since the driver and stepping motor remain at a high temperature. Failure to do so may cause burns. In particular, the temperature of the stepping motor rises considerably depending on the operating conditions. Make sure to keep the motor surface temperature less than 100°C.
- Immediately stop operation in case of anomaly. Failure to do so may cause an electric shock, injury or fire.

- Do not make extreme setting changes as doing so may result in unstable operations. Failure to follow this may cause injury.
- During trial operations, firmly stabilize the stepping motor, and confirm operations by disconnecting from the mechanical system before connecting with it. Failure to follow this may cause injury.
- Take safety measures such as covering the rotating parts of the stepping motor during operation to prevent them from being touched. Failure to follow this may cause injury.
- When an alarm is activated, remove the cause and ensure safety before resuming operations. Failure to follow this may cause injury.
- Stay away from equipment when power is restored after an outage because the system may restart suddenly. (Take measures to secure the safety even when it restarts on such occasions.) Failure to do so may cause injury.
- Use the right power supply for the motor. Failure to follow this may cause product failures.
- The electromagnetic brake is designed to hold the motor position in place. Do not use it as dynamic braking. Doing so may cause the breakdown of the system.
- Secure the key when operating the motor with a key. Failure to follow this may cause injury.
- For use in applications where varying loads are applied to the shaft, contact us in advance. Use in environments with varying loads might result in failure.

Maintenance

- Be careful when performing maintenance services or inspection as the driver and stepping motor frames get hot. Failure to follow this may result in a burn.
- It is recommended that the electrolytic condenser of the driver is replaced with a new one as preventive maintenance after using for 5 years (the expected life in an average operating environment of 40°C). The expected life of the fuse is 10 years in an average operating environment of 40°C. Thus, periodical replacement is recommended.
- Contact us or your point of sale for repair. If the product is disassembled by the user, it may become inoperable.
- Stepping motor's oil seals, electromagnetic brakes, bearings are life-limited parts. Determine when to replace them based on the results of the actual equipment evaluation.

Transportation

- Handle the product with care during transportation so as to prevent from dangers such as tumbling or overturning.
- Do not hold with the cable or the motor shaft when transporting. Failure to follow this may cause product damage or injury.

Disposal

- Dispose of stepping drivers and motors as industrial waste.

PROHIBITED

Storage

- Avoid storing products in environments exposed to rain or water drops or with hazardous gas or liquid. Failure to follow this may cause failures.

Maintenance

- Do not disassemble or repair the product. Failure to follow this may cause fire or electric shock.

General

- Do not remove the nameplate. Using motors with incorrect ratings may result in fire.

COMPULSORY

Storage

- Store the product out of direct sunlight within the specified temperature and humidity ranges.
- If the driver has been stored for a long period (3 years or longer as a general guide), contact us. The capacitance of electrolytic capacitors can decrease through long-term storage, which may cause malfunctions.

Operation

- Install an emergency stop circuit to the outside of equipment to turn the power off immediately whenever needed.
- Operate the motor within the specified ambient temperature and humidity ranges.

Transportation

- Follow the instructions displayed on the package box and avoid excessively stacking boxes.

■ Selection Guide by Mechanism

Typical mechanism examples and required selection criteria are shown below.
Provide us with these information when consulting us for selection.

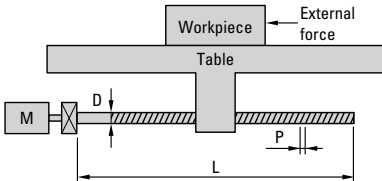
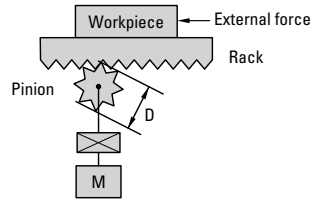
Ball screw		Rack & Pinion	
			
External force	F		N
Workpiece + table mass	W		kg
Ball screw diameter	D		m
Ball screw length	L		m
Ball screw pitch	P		m
Ball screw density	ρ		kg/m ³
Friction coefficient	μ		
Gear ratio *	G		
Mechanical efficiency	η		
External force	F		N
Workpiece mass + rack mass	W		kg
Pinion diameter	D		m
Pinion thickness	L		m
Pinion density	ρ		kg/m ³
Friction coefficient	μ		
Gear ratio *	G		
Mechanical efficiency	η		

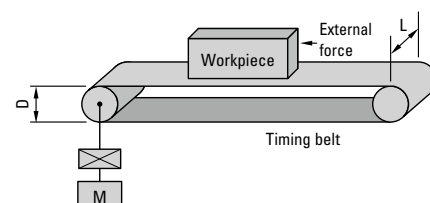
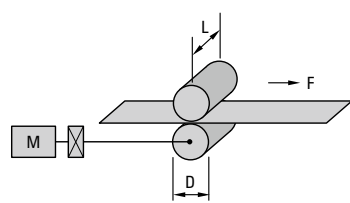
Belt drive		Roll feed	
			
External force	F		N
Workpiece mass + belt mass	W		kg
Pulley diameter	D		m
Pulley width	L		m
Pulley density	ρ		kg/m ³
Gear ratio *	G		
Mechanical efficiency	η		
Sheet tension	F		N
Roll diameter	D		m
Roll width	L		m
Roll density	ρ		kg/m ³
Gear ratio *	G		
Mechanical efficiency	η		

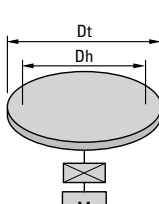
Rotary indexing table			
			
Table mass	W		kg
Table diameter	Dt		m
Table support diameter Dh			m
Friction coefficient of table support	μ		
Gear ratio *	G		
Mechanical efficiency	η		

* Calculation of gear ratio (G)

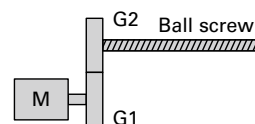

$$G = \frac{\text{Number of screw threads (G2)}}{\text{Number of motor gear teeth (G1)}}$$

MEMO



■ ECO PRODUCTS

ECO PRODUCTS are designed to reduce the environmental impacts throughout the product's life cycle. Ranging from design to manufacturing stages, the environmental impact of a product and its packaging materials is assessed against the eco-design requirements. Those products that satisfy the requirements are accredited as ECO PRODUCTS.

Notes Before Purchase

- Read the accompanying Instruction Manual carefully prior to using the product.
- Do not use this product in an environment where vibration is present, such as in moving vehicles or shipping vessels.
- Do not modify or alter the product in any way.

Please contact us beforehand if you intend to use this product in the following applications.

- Medical equipment that may have an effect on human life
- Systems or equipment that may have a major impact on society or on the public
- Special applications related to aviation and space, nuclear power, electric power, submarine repeaters, etc.